

**Timer Selection Guides**

- Relay Output..... 2.2
- Solid State Output..... 2.4

**Timer Function Selection**

- Selecting a Function..... 2.6
- Selection Questions..... 2.6
- Understanding Time Diagrams..... 2.6
- International Timing Function Symbols..... 2.7

**Popular Functions**

- (M) -- Delay on Make..... 2.7
- Extra Functions Included in Some Delay on Make Timers..... 2.7
- (AM) -- Accumulative Delay on Make..... 2.7
- (I) -- Interval..... 2.7
- Interval on Loss of Power (Impulse-OFF w/o Auxiliary Voltage)..... 2.7
- Extra Functions Included in Some Interval Timers..... 2.7
- (RE, RD, RXE, RXD) -- Recycling..... 2.8
- Extra Functions Included in Some Recycling Timers..... 2.8
- (B) -- Delay on Break..... 2.8
- Extra Functions Included in Some Delay on Break Timers..... 2.8
- True Delay on Break (OFF- delay w/o Auxiliary Voltage)..... 2.8
- (UB) -- Inverted Delay on Break..... 2.8
- (S, SD) -- Single Shot..... 2.9
- Extra Functions Included in Some Single Shot Timers..... 2.9
- (PSD) -- Retriggerable Single Shot (Motion Detector)..... 2.9
- (PSE) -- Retriggerable Single Shot (Motion Detector)..... 2.9
- (US) -- Inverted Single Shot..... 2.9
- (TS) -- Trailing Edge Single Shot (Impulse-OFF)..... 2.9
- (TI) -- Trailing Edge Interval (Impulse-OFF with Auxiliary Voltage)..... 2.9

**Two Functions in One Timer**

- Star Delta - Two Output Relays..... 2.10
- Star Delta - One Relay Output..... 2.10
- (MB) -- Delay on Make/Delay on Break..... 2.10
- Extra Functions Included in Some Delay on Make/Delay on Break Timers..... 2.10
- (MI) -- Delay on Make/Interval..... 2.10
- (AMI) -- Accumulative Delay on Make/Interval..... 2.10
- (MRE) -- Delay on Make/Recycle..... 2.11
- (MS) -- Delay on Make/Single Shot..... 2.11
- (IRE) -- Interval/Recycle..... 2.11
- (BRE) -- Delay on Break/Recycle..... 2.11
- (SRE) -- Single Shot/Recycle..... 2.11
- (SL) -- Single Shot/Lockout..... 2.11
- (IM) -- Interval/Delay on Make..... 2.11

**Counting and Switching Functions**

- (F) -- Flip-Flop, Leading Edge..... 2.12
- (FT) -- Alternating Relay (Trailing Edge Flip-Flop)..... 2.12
- (C) -- Counter/Pulsed Output..... 2.12
- (CI) -- Counter/Interval Output..... 2.12

## Selection Guide

### Solid State Timers with Relay Outputs

For detailed product specifications, refer to catalog pages.

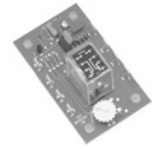





	Plug-in Switch Adjust		Plug-in Knob Adjust		HR Series Onboard & External Adjust or Fixed		ERD Series Knob & External Adjust or Fixed		OR Series Knob & External Adjust or Fixed	
<b>Dedicated Function</b>	Series	Page	Series	Page	Series	Page	Series	Page	Series	Page
Delay on Make (ON Delay)	TDM	5.2	TRM	5.4	HRDM	5.8	ERDM	5.10	ORM	5.12
Interval (Impulse ON)	TDI	5.100	PRLM	5.6	HRPS	3.10				
Recycling Equal Times			TRS	5.72	HRDI	5.102	ERDI	5.104	ORS	5.80
Recycling Unequal Time (Pulse Generator)			PRLS	5.74	HRPS	3.10				
Recycling (Pulse Generator)	TDR	5.126	TRU	4.6	HRD3 (e)	5.130	ERD3 (e)	5.132		
Single Shot (Pulse Former)					HRPS	3.10				
Delay on Break (OFF-delay)					HRDR	5.128				
Delay on Make / Delay on Break	TDS	5.70	TRS	5.72	HRPD	3.8				
Delayed Interval (Single Pulse Generator)			PRLS	5.74	HRDS	5.76	ERDI	5.104	ORS	5.80
Other Functions Available					HRD9 (r)	5.96				
			TRB	5.44	HRPS	3.10				
			PRLB	5.46	HRDB	5.48			ORB	5.50
					HRPS	3.10				
					HRPD	3.8				
					HRPD	3.8				
					See Section 3					
<b>Multifunction</b>	See Section 4		See Section 4							
<b>Time Delay &amp; Adjustment</b>										
Time Delay Range	0.1 s to 2.8 h (!) TRDU to 1705 h		0.05 s to 10 m (!) TRU 16 h		0.1 s to 1000 m		0.1 s to 500 m (!)		0.05 to 300 s (!)	
Repeat Accuracy	≤ 0.1%		≤ 2%		≤ 0.5%		≤ 0.5% to 2%		≤ 2%	
Knob Adjust				•		•		•		•
Onboard Adjust						•		•		•
Switch Adjust	•					•		•		•
External Adjust			TR Series			•		•		•
Factory Fixed			TR Series			•		•		•
<b>General Features</b>										
DIN Rail Mounting (35 mm)	Socket Required		Socket Required		Adaptor Required		•		•	
Surface Mounting	Socket Required		Socket Required		•		•		•	
Output Relay	SPDT or DPDT		SPDT or DPDT		SPDT		SPDT or DPDT		SPDT or DPDT	
Resistive Rating at Contacts	10 A		10 A		30 A					
Screw Terminals	Socket Required		Socket Required							
DPDT Relay/Resistive Rating							10 A		10 A	
SPDT Relay/Resistive Rating					30 A		10 A		10 A	
Popular AC & DC Voltages	•		•		•		•		ORB, ORS AC Only	
Encapsulated					•		•			
Quick Connects					•		•		•	
Dimensions	in	1.78 x 2.39 x 3.20	in	1.78 x 2.39 x 3.62	in	2.02 x 3.02 x 1.50	in	2.50 x 3.50 x 1.70	in	2.12 x 3.69 x 1.88
	mm	45.2 x 60.7 x 81.3	mm	45.2 x 60.7 x 91.6	mm	51.3 x 76.7 x 38.1	mm	63.5 x 88.9 x 43.2	mm	53.9 x 93.7 x 47.8

(a) = includes time accumulation; (e) = equal time delays (see Flashers Selection Guide for more options); (i) = includes an instantaneous contact; (tb) = true delay on break; (te) = trailing edge triggered; A = amps resistive rating; (!) = most series consult catalog pages; (r) = retriggerable

# Selection Guide

## Solid State Timers with Relay Outputs

Timer Selection

<p>For detailed product specifications, refer to catalog pages.</p>	<p><b>KR Series</b> Onboard &amp; External Adjust or Fixed</p> 	<p><b>S Series</b> Onboard Adjust</p> 	<p><b>E Range</b> Onboard Adjust</p> 	<p><b>D Range</b> Onboard Adjust</p> 
---	--	---	--	--

Available for download at: [www.ssac.com/sg21.pdf](http://www.ssac.com/sg21.pdf)

Dedicated Function	Series	Page	Series	Series	Series
Delay on Make (ON-Delay)	KRDM KRPS	5.14 3.6	CT-ERS	CT-ERE	CT-ERD
Interval (Impulse ON)	KRDI KRPS	5.106 3.6	CT-WBS	CT-VWE	CT-VWD
Interval, Trailing Edge (Impulse OFF)				CT-AWE	
Interval, True Trailing Edge (Impulse OFF)				CT-AWE	
Recycling Equal Times				CT-EBE	CT-EBD
Recycling (Pulse Generator)	KRD3 (e) KRPS	5.136 3.6	CT-WBS (e)		
Recycling, Unequal Times (Pulse Generator)	KRDR KRPD	5.134 3.4			CT-TGD
Single Shot (Pulse Former)	KRDS KRD9 (r)	5.82 5.98			
Delay on Break (OFF - delay)	KRDB KRPS	5.52 3.6	CT-AHS CT-APS	CT-AHE	CT-AHD
True Delay on Break (OFF - delay)			CT-ARS (tb)	CT-ARE (tb)	
Delay on Make / Delay on Break	KRPD	3.4			
Star Delta			CT-SDS	CT-SDE CT-YDE	CT-SDD CT-SAD
Delayed Interval (Single Pulse Generator)	KRPD	3.4			
Other Functions Available	See Section 3		See Section 4	See Section 4	See Section 4
<b>Time Delay &amp; Adjustment</b>					
Time Delay Range	100 m to 1000 h		0.05 s to 300 h (!)	0.1 s to 300 s (!)	.05 s to 100 h
Repeat Accuracy	≤ 0.5%		≤ 0.2%	≤ 1%	≤ 0.5%
Knob Adjust					
Onboard Adjust	•		•	•	•
Switch Adjust					
External Adjust	•		Some Series		
Factory Fixed	•				
<b>General Features</b>					
DIN Rail Mounting (35 mm)	Adaptor Required		•	•	•
Surface Mounting	•		Adaptor Required	Adaptor Required	Adaptor Required
Popular AC & DC Voltages					
Encapsulated					
Quick Connects	•				
Output Relay	SPDT		SPDT or DPDT (i)	SPDT	SPDT or DPDT
Resistive Rating at Contacts	10 A		4 A	4 A	6 A
Screw Terminals			•	•	•
Dimensions	in mm	2.0 x 2.0 x 1.21 50.8 x 50.8 x 30.7	0.89 x 3.07 x 3.98 22.5 x 78 x 101	0.89 x 3.07 x 3.09 22.5 x 78 x 78.5	.69 x ≤3.15 x 2.48 17.5 x ≤80 x 63

(e) = equal time delays; (r) = retriggerable; (!) = Most series consult catalog pages; (i) = includes an instantaneous contact on some series

## Selection Guide

### Solid State Timers with Solid State Output

For detailed product specifications, refer to catalog pages.

Digi-Timer  
Onboard,  
Switch, Fixed, or  
External Adjust



MicroTime  
Onboard or  
Switch Adjust



Digi-Timer  
Onboard,  
Switch, Fixed or  
External Adjust



Onboard, Fixed,  
or  
External Adjust



	Series	Page	Series	Page	Series	Page	Series	Page
<b>Dedicated Function</b>								
Delay on Make (ON Delay)	TSD1 KSD1	5.20 5.26			TDU KSDU	5.16 5.16	TMV/TSU TS1 TS4	5.18 5.28 5.40
Delay on Make Normally Closed	TSD4 KSD4	5.34 5.38						
Delay on Break (OFF-delay)	TSD7 TSDS KSDS	5.62 5.86 5.90	ASQU/ASTU DSQU/DSTU	4.8 4.10	TDUB	5.54	TSB	5.66
Delay on Break (2 Terminal) Single Shot (Pulse Former)	TSD7 TSDS KSDS	5.62 5.86 5.90	ASQU/ASTU DSQU/DSTU	4.8 4.10	TDUS	5.84	TSS	5.92
Single Shot (Motion Detector) Interval (Impulse ON)	KSPS (r) TSD2 KSD2	3.18 5.110 5.120	ASQU/ASTU DSQU/DSTU	4.8 4.10	TDUI	5.108	TS2	5.122
Interval (DC Volts Only) Interval (2 Terminal) Recycling (Delays Separately Adjustable)	TSD6 (d) TSD7 ESDR TSDR (f) KSDR	5.114 5.116 5.140 5.142 5.144					TS6 (d)	5.122
Recycling (Equal Delays)	TSD3 (e) KSD3 (e)	5.148 5.150	ASQU/ASTU DSQU/DSTU	4.8 4.10				
Delay on Make/ Delay on Break Delay on Make/Interval	KSPD ESD5 KSPD	3.16 5.158 3.16						
Other Functions Available	See Section 3							
<b>Multifunction</b>			•					
<b>Time Delay &amp; Adjustment</b>								
Typical Time Delay Range	0.1 s to 1000 m		0.1 s to 100 m (!)		0.1 s to 170 m (!)		0.05 to 600 s	
Repeat Accuracy	≤ 0.1 to 1%		≤ 0.1 to 1%		≤ 0.5%		≤ 0.5 to 2%	
Onboard Adjustment	•		AS_U Series				Some (!)	
Switch Adjustment	KSPU	3.20	DS_U Series		Most Series (!)			
External Adjustment	•						•	
Factory Fixed	Except KSDR Series				KSDU Series		•	
<b>General Features</b>								
DIN Rail Mounting	Adaptor Required		•		Adaptor Required		Adaptor Required	
Surface Mounting	•		•		•		•	
Output Rating	1 A		0.7 A		1 A		1A	
Popular AC Voltages	•		•		•		•	
Popular DC Voltages	•		•		•		•	
Screw Terminals	•		•		•		•	
Quick Connects	•		•		•		•	
Dimensions	in mm	2.0 x 2.0 x 1.21 50.8 x 50.8 x 30.7	0.69 x 3.0 x 2.41 17.5 x 76.2 x 61.2		2.0 x 2.0 x 1.21 50.8 x 50.8 x 30.7		2.0 x 2.0 x 1.21 50.8 x 50.8 x 30.7	

(d) = DC Volts Only; (e) = equal time delays; (s) = 3 or 4 channel sequencer; (!) = most series consult catalog pages;  
(r) = retriggerable; (f) = at least one delay must be specified as fixed

# Selection Guide Solid State Timers

Timer  
Selection

2

For detailed product specifications, refer to catalog pages.

Digi-Power  
Onboard, Fixed  
or  
External Adjust

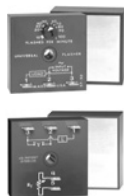

Digi-Set  
Switch Adjust



PC Mount /  
Wires Fixed



Surface Mount  
2.5 x 3.5

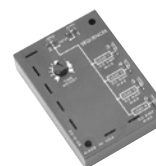

E Range  
Knob Adjust



Catalog pages are  
Available for download at:  
[www.ssac.com/sg22.pdf](http://www.ssac.com/sg22.pdf)

	Series	Page	Series	Page	Series	Page	Series	Page	Series
<b>Dedicated Function</b>									
Delay on Make (ON Delay)	THDM THD1 TH1	5.22 5.24 5.30			MSM	5.32			CT-EKE
Delay on Make Normally Closed	THD4	5.36							
Delay on Break (OFF - delay)	THDB	5.58							CT-AKE
Single Shot (Pulse Former)	THDS THS	5.88 5.94							
Interval (Single Pulse on Operate)	THD2 TH2	5.112 5.124							
Interval (DC Volts Only)									
Interval (2 Terminal)	THD7	5.118							
Recycling (Delays Separately Adjust)	NHPD	3.22	RS	5.138					
Recycling (Equal Delays)	THD3	5.146					SQ (s) (e)	5.154	
Percentage	PTHF	5.152							
Delay on Make/ Delay on Break	NHPD	3.22							
Delay on Make/Interval	NHPD	3.22							
Other Functions Available	See Section 3								
<b>Multifunction</b>									See Section 4
<b>Time Delay Adjustment</b>									
Typical Time Delay Range	0.1 s to 1000 m		0.1 s to 1023 h		0.05 to 180 s		0.1 s to 100 m		0.1 to 300 s
Repeat Accuracy	≤ 0.5%		≤ 0.1%		≤ 5%		≤ 1%		≤ 1%
Onboard Adjustment	Most (!)						•		•
Switch Adjustment	NHPU 3.26		•						
External Adjustment	•						•		
Factory Fixed	•				•		•		
<b>General Features</b>									
DIN Rail Mounting									•
Surface Mounting	•		•		•		•		Adaptor Required
Output Rating	6, 10, or 20 A		1 A		0.5 A		1 A		0.7 to 0.8 A
Popular AC Voltages	•		•		•		•		•
Popular DC Voltages	Delay On Make Only		•		•				CT-AKE AC Only
Screw Terminals					2 Wire Leads or PC Board Mount				•
Male Quick Connects	•		•				•		
Dimensions	in mm	2.0 x 2.0 x 1.51 50.8 x 50.8 x 38.4	3 x 2 x 1.5 76.7 x 50.8 x 38.1		0.94 x 1.5 23.8 x 38.1		2.5 x 3.5 x 1.22 63.5 x 88.9 x 31		0.89 x 3.07 x 3.09 22.5 x 78 x 78.5

(d) = DC Volts only; (e) = equal time delays; (s) = 3 or 4 channel sequencer; (!) Some Series consult catalog pages

# Timer Functions

## Selecting a Function

### Selecting a Timer's Function

Selecting one of the five most common timing functions can be as easy as answering three questions on the chart below. If you have trouble answering these questions, try drawing a connection diagram that shows how the timer and load are connected. Time diagrams and written descriptions of the five most popular functions, plus other common functions appear on the following pages. Instantaneous contacts, accumulation, pause timing functions, and flashing LED's are included in some units to expand the versatility of the timer. These expanded operations are explained on the product's catalog page. Time diagrams are used on these pages along with text and international symbols for functions.

### Function Selection Guide

#### Selection Questions

- 1) The timing starts when the initiate (starting) contacts are:
  - A) Closed B) Opened
- 2) What is the status of the output (or load) during timing:
  - A) On B) Off C) On/Off
- 3) Will the load de-energize (or remain de-energized) if the initiate (starting) contacts are opened during timing:
  - A) Yes B) No

### THE FIVE MOST USED FUNCTIONS

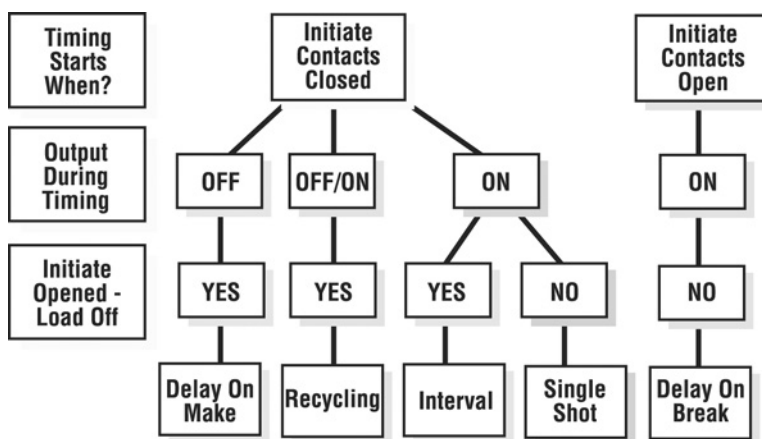

### Understanding Time Diagrams

Time diagrams are used to show the relative operation of switches, controls, and loads as time progresses. Time begins at the first vertical boundary. There may be a line indicating the start of the operation or it may just begin with the transition of the device that starts the operation. Each row in the time diagram represents a separate component. These rows will be labeled with the name of the device or its terminal connection numbers. In a bistable or digital system, the switches, controls, or loads can only be ON or OFF. The time lines are drawn to represent these two possible conditions. Vertical lines are used to define important starting or ending points in the operation.

The example to the right is the most common type of time diagram in use in North America. It shows the energizing of loads, and the closing of switches and contacts by an ascending vertical transition of the time line. Opening switches or contacts or de-energizing loads are represented by descending vertical transitions.

### TIME DIAGRAM

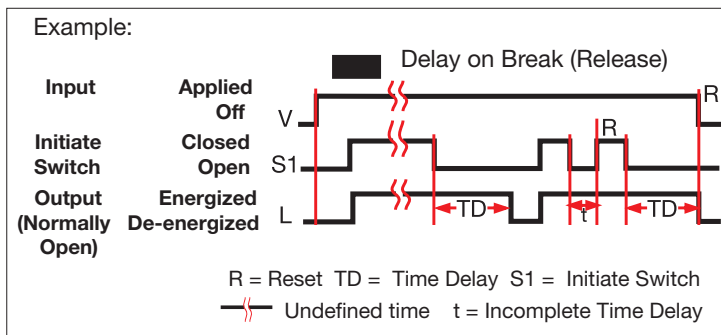

# Timer Functions

## Popular Functions

### INTERNATIONAL TIMING FUNCTION SYMBOLS

	= Delay on Make; ON-delay		= Flasher - OFF Time First; Recycling Equal Times - OFF First
	= Delay on Break; OFF-delay		= Recycling - Unequal Times; Pulse Generator
	= Delay on Make & Break; ON and OFF-delay		= Recycling - Unequal Times Starting with ON or OFF
	= Interval; Impulse-ON		= Delay on Make & Interval; Single Pulse Generator
	= Trailing Edge Interval; Impulse-OFF		= Star-delta Motor Starting - Twice Delayed on ON
	= Single Shot; Pulse Former		= Star-delta Motor Starting - with Impulse-ON
	= Flasher - ON Time First; Recycling Equal Times - ON First		= Star-delta Motor Starting

### Delay on Make: (ProgramaCube® Function M)

(ON-delay, Delay on Operate, On Delay, Operate Delay, Delay On, Prepurge Delay)

**OPERATION:** Upon application of input voltage, the time delay begins. The output (relay or solid state) is de-energized before and during the time delay. At the end of the time delay, the output energizes and remains energized until input voltage is removed.

**RESET:** Removing input voltage resets the time delay and output.

See: HRPS, KRPS, KSPS, KSPU, NHPS, NHPU, TDM, TRDU

Extra Functions Included in Some Delay on Make (DOM) Timers:

**Accumulating Time Delay Feature: (ProgramaCube® Function AM)** Some DOM timers allow the time delay to be stopped and held and then resumed by opening and closing an external switch. The total time delay, TD is the sum of the accumulated partial time delays, "t".

See: KRPD, KRPS, HRPS, NHPS, KSPD, KSPS, TRDU, CT-ERS, CT-MBS, CT-MFS

**Instantaneous Contacts:** Some DOM timers have a set of instantaneous contacts in addition to the delayed contacts. Instantaneous contacts energize when input voltage is applied and remain until voltage is removed.

See: CT-MBS, CT-MFS, CT-ERS, CT-MVS

**Delay on Make, Normally Closed Output:** All relay output delay on make timers with normally closed contacts include this function. (See Delay on Make NC Contacts) This function is also available in solid state output timers. The solid state output energizes when input voltage is applied. The time delay begins when an optional initiate switch S1 is closed (timing starts when voltage is applied if S1 is not used). The output de-energizes at the end of the time delay.

**Reset:** Opening S1 resets the time delay and the output immediately energizes (or remains energized). Removing input voltage resets the time delay and de-energizes the output.

See: KSD4, THD4, TS4, TSD4

### Interval: (ProgramaCube® Function I)

(Impulse-ON, Single Pulse on Operate, On Interval, Interval On, Pulse Shaping, Bypass Timing)

**OPERATION:** Upon application of input voltage, the time delay begins. The output (relay or solid state) energizes during the time delay. At the end of time delay the output de-energizes and remains de-energized until input voltage is removed.

**RESET:** Removing input voltage resets the time delay and output.

See: HRPS, KRPS, KSPS, KSPU, NHPS, NHPU, TDI, TSD2

Extra Functions Included in Some Interval Timers:

### Interval on Loss of Power: (Impulse -OFF without Auxiliary Voltage)

**Operation:** Supply voltage must be applied for a minimum time. The output remains OFF and timing reset until supply voltage is removed. When voltage is removed the output energizes and the time delay begins. When the time delay ends the output de-energizes.

**Reset:** Reapplying voltage during the time delay resets the delay and de-energizes the output immediately. See: CT-AWE

**Instantaneous Contacts:** Some Interval timers have a set of instantaneous contacts in addition to the delayed contacts. Instantaneous contacts energize when input voltage is applied and remain until voltage is removed.

See: CT-MBS, CT-MFS, CT-VWS, CT-MVS

**Accumulating Time Delay Feature:** Some Interval timers allow the time delay to be stopped and held and then resumed by opening and closing an external switch.

See: CT-MBS, CT-MFS, CT-VWS

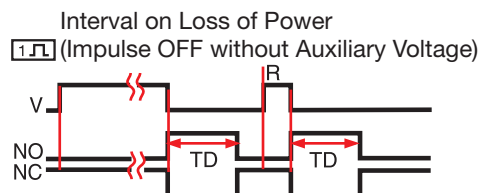
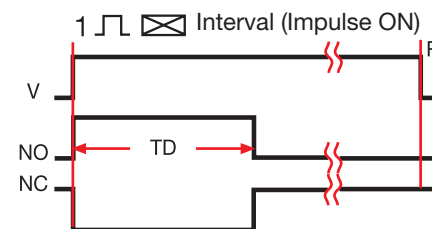
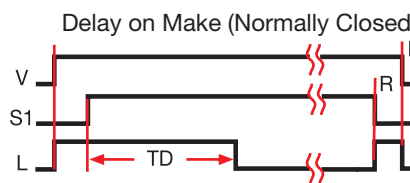
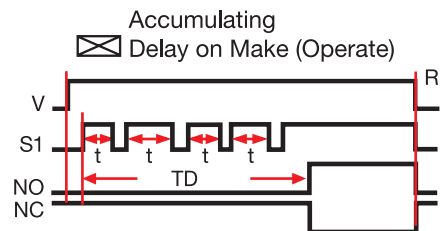
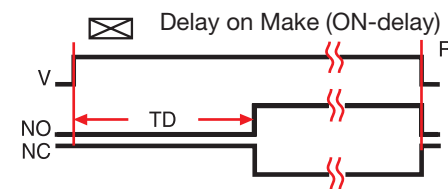

### Legend

V = Voltage	NO = Normally Open Contact
R = Reset	NC = Normally Closed Contact
TD = Time Delay	t = Incomplete Time Delay
S1 = Initiate Switch	L = Load
	= Undefined time

# Timer Functions Popular Functions

## Recycling: (ProgramaCube® Functions RE, RD, RXE, RXD)

(Flasher, Pulse Generator, Recycle Timing, Repeat Cycle, Duty Cycling)

**OPERATION:** Upon application of input voltage, the output (relay or solid state) energizes and the ON time begins. At the end of the ON time, the output de-energizes and the OFF time begins. At the end of the OFF time, the output energizes and the cycle repeats as long as input voltage is applied. The OFF time may be the first delay in some recycling timers.

**RESET:** Removing input voltage resets the output and time delays, and returns the sequence to the first delay.

The time delays in some recycling timers are equal  $TD1=TD2$ . Flashers are an example of this type of recycling timer. Others have separately selectable time delays.

See: HRPD, HRPS, KRPD, KRPS, KSPD, KSPS, KSPU, NHPD, NHPS, NHPU, TDR

Extra Functions Included in Some Recycling Timers:

**Instantaneous Contacts:** Some Recycling timers have a set of instantaneous contacts in addition to the delayed contacts. Instantaneous contacts energize when input voltage is applied and remain until voltage is removed.

See: CT-EBS, CT-MBS, CT-MFS, CT-MVS

**Reset Switch:** Closing an external switch transfers the output and resets the sequence to the first delay.

See: HRDR, CT-EBS, CT-MBS, CT-MFS, CT-MVS

**Accumulating Time Delay Feature:** Some Recycling timers allow the time delay to be stopped and held and then resumed by opening and closing an external switch.

See: CT-TGS

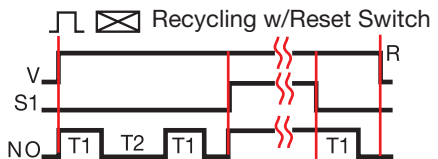
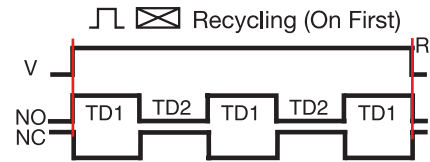

S1 = Reset Switch

## Delay on Break: (ProgramaCube® Function B)

(Delay on Release, OFF-delay, Release Delay, Postpurge Delay)

**OPERATION:** Input voltage must be applied before and during timing. Upon closure of the initiate switch, the output (relay or solid state) energizes. The time delay begins when the initiate switch is opened. The output remains energized during timing. At the end of the time delay, the output de-energizes. The output will energize if the initiate switch is closed when input voltage is applied.

**RESET:** Reclosing the initiate switch during timing resets the time delay. Removing input voltage resets the time delay and output.

See: HRPS, HRPV, KRPS, KSPS, KSPU, NHPS, NHPV, TRDU, TDB

Extra Functions Included in Some Delay on Break (DOB) Timers:

**Instantaneous Contacts:** Some DOB timers have a set of instantaneous contacts in addition to the delayed contacts. Instantaneous contacts energize when input voltage is applied and remain until voltage is removed.

See: CT-AHS, CT-APS, CT-MBS, CT-MFS, CT-MVS

**Accumulating Time Delay Feature:** Some DOB timers allow the time delay to be stopped and held and then resumed by opening and closing an external switch.

See: CT-AHS, CT-APS, CT-MBS, CT-MFS

Related Functions:

### True Delay on Break: (OFF-delay without Auxiliary Voltage)

**OPERATION:** When input voltage is applied, the output energizes. The time delay begins when input voltage is removed. The output de-energizes at the end of the time delay.

See: CT-ARE, CT-ARS

### Inverted Delay on Break: (ProgramaCube® Function UB)

**OPERATION:** Input voltage must be applied before and during timing. Upon closure of the initiate switch S1, the output (relay or solid state) de-energizes. The time delay begins when S1 is opened. The output remains de-energized during timing. At the end of the time delay, the output energizes. The output remains de-energized if S1 is closed when input voltage is applied.

**RESET:** Reclosing S1 during timing resets the time delay. Removing input voltage resets the time delay and output.

See: HRPS, HRPV, KRPS, KSPS, KSPU, NHPS, NHPV, TRDU

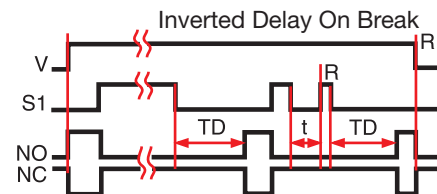
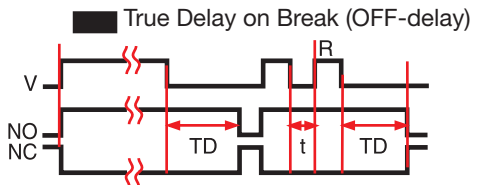
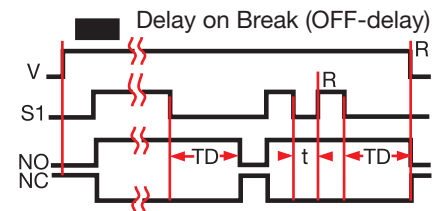

### Legend

- V = Voltage
- R = Reset
- T1 = ON Time
- T2 = OFF Time
- S1 = Initiate Switch
- NO = Normally Open Contact
- NC = Normally Closed Contact
- t = Incomplete Time Delay
- TD, TD1, TD2 = Time Delay
- = Undefined Time

# Timer Functions

## Popular Functions

### Single Shot: (ProgramaCube® Functions S or SD)

(Pulse Former, One Shot Relay, Single Shot Interval, Pulse Shaping)

**OPERATION:** Input voltage must be applied before and during timing. Upon momentary or maintained closure of the initiate switch, the output (relay or solid state) energizes and the time delay begins. At the end of the delay, the output de-energizes. Opening or reclosing the initiate switch during timing has no effect on the time delay. Note (for most single shot timers): If the initiate switch is closed when input voltage is applied, the output energizes and the time delay begins.

**RESET:** Reset occurs when the time delay is complete and the initiate switch is opened. Removing input voltage resets the time delay and output.

See: HRPS, HRPV, KRPS, KSPS, KSPU, NHPS, NHPV, TDS, TSDS, TRDU

Extra Functions Included in Some Single Shot Timers:

**Instantaneous Contacts:** Some Single Shot timers have a set of instantaneous contacts in addition to the delayed contacts. Instantaneous contacts energize when input voltage is applied and remain until voltage is removed. See: CT-AWS, CT-MBS, CT-MFS, CT-MVS

**Accumulating Time Delay Feature:** Some single shot timers allow the time delay to be stopped and held and then resumed by opening and closing an external switch. See: CT-AWS, CT-MBS, CT-MFS

Related Functions:

### Retriggerable Single Shot (Motion Detector): (ProgramaCube® Function PSD)

(Motion Detector, Zero Speed Switch, Watchdog Timer, Missing Pulse Timer)

**OPERATION:** Input voltage must be applied prior to and during timing. The output (relay or solid state) is de-energized. When the initiate switch S1 closes momentarily or maintained, the output energizes and the time delay begins. Upon completion of the delay, the output de-energizes.

**RESET:** Reclosing S1 resets the time delay and restarts timing. Removing input voltage resets the time delay and output.

See: HRD9, HRPS, HRPV, KR9, KRPS, KSPU, NHPS, NHPV, TRDU, TRU

### Retriggerable Single Shot (Motion Detector): (ProgramaCube® Function PSE)

**OPERATION:** Similar to retriggerable single shot function PSD above except, when input voltage is applied, the output (relay or solid state) immediately energizes and timing begins. At the end of the time delay, the output de-energizes. The unit will timeout as long as S1 remains open or closed for a full time delay period.

**RESET:** During timing, reclosing S1 resets and restarts the time delay and the output remains energized. After timeout, reclosing S1 starts a new operation. Removing input voltage resets the time delay and the output. See: KR9

### Inverted Single Shot: (ProgramaCube® Function US)

**OPERATION:** Input voltage must be applied before and during timing. Upon momentary or maintained closure of the initiate switch S1, the output (relay or solid state) de-energizes. At the end of the time delay, the output energizes. Opening or reclosing S1 during timing has no effect on the time delay. The output will remain de-energized if S1 is closed when input voltage is applied.

**RESET:** Reset occurs when the time delay is complete and S1 is open. Removing input voltage resets the time delay and output.

See: HRPS, HRPV, KRPS, KSPS, KSPU, NHPS, NHPV, TRDU

### Trailing Edge Single Shot (Impulse-OFF): (ProgramaCube® Function TS)

**OPERATION:** Input voltage must be applied before and during timing. When the initiate switch S1 opens, the output (relay or solid state) energizes. At the end of the time delay, the output de-energizes. Reclosing and opening S1 during timing has no effect on the time delay. The output will not energize if S1 is open when input voltage is applied.

**RESET:** Reset occurs when the time delay is complete and S1 is closed. Removing input voltage resets the time delay and output.

See: HRPS, KRPS, KSPS, KSPU, NHPV, TRDU, CT-AWS, CT-MBS, CT-MFS, CT-MVS

### Trailing Edge Interval (Impulse - OFF with auxiliary voltage):

**OPERATION:** Supply voltage must be applied before and during timing. As long as the S1 initiate switch is closed, the output (relay or solid state) is de-energized and timing is reset. When S1 opens, the output energizes and the time delay begins. At the end of the time delay, the output de-energizes. The output will energize and timing begins if S1 is open when supply voltage is applied.

**RESET:** Reclosing S1 during timing resets timing and the output de-energizes immediately. Removing supply voltage resets the time delay and the output.

See: CT-VWE, CT-MFS, CT-MBS, CT-MVS

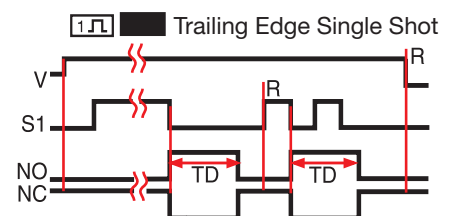
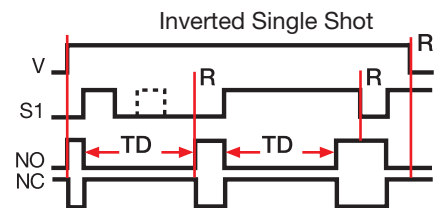
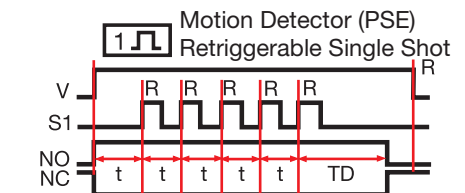
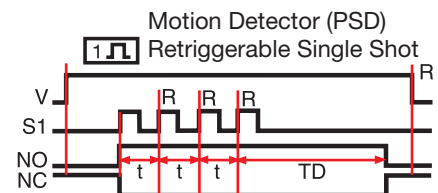
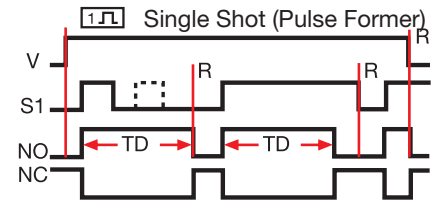

## Timer Functions Two Functions in One Timer

2

### Star Delta - Two Output Relays: (Motor Starting Timer)

**OPERATION:** Upon application of input voltage, the timer's first output relay and the star contactor energizes. When the start time delay is completed, the first relay de-energizes [CT-MFS] (or remains energized in CT-YDAV). Fifty milliseconds later, the second output relay and the delta contactor energize and remain energized until input voltage is removed.  
**RESET:** Removing input voltage resets the time delays and outputs.  
 See: CT-MBS, CT-MFS, CT-MVS, CT-YDAV, CT-YDEW

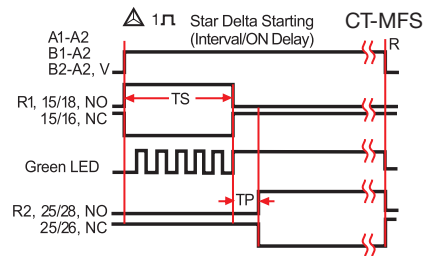

### Star Delta - One Relay Output

**OPERATION:** Star Delta starting is possible with a SPDT relay output or 1 NO and 1 NC set of contacts. A number of external connections are required. See CT-SDE and CT-YDE for complete wiring diagram and description.  
 See: CT-SDE, CT-YDE

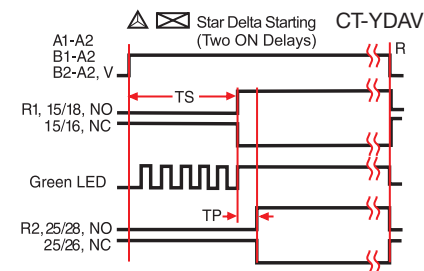

### Delay on Make/Delay on Break: (ProgramaCube® Function MB)

(ON-delay/OFF-delay, Delay on Operate/Delay on Release, Sequencing ON & OFF, Fan Delay, Prepurge & Postpurge)

**OPERATION:** Input voltage must be applied at all times. The output (relay or solid state) is de-energized. Upon closure of the S1 initiate switch, the delay on make time delay (TD1) begins. At the end of TD1, the output (relay or solid state) energizes. Opening S1 starts the delay on break time delay (TD2). At the end of TD2, the output de-energizes.  
**RESET:** Removing input voltage resets time delays and the output. If S1 is a) opened during TD1, then TD1 is reset and the output remains de-energized. b) reclosed during TD2, then TD2 is reset and the output remains energized.  
 See: HRPD, KRPD, KSPD, NHPD, CT-EAS, CT-EVS

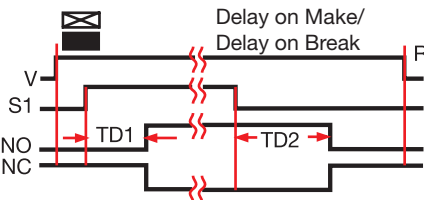

Extra Functions Included in Some Delay on Make/Delay on Break Timers:

**Instantaneous Contacts:** Some DOM/DOB timers have a set of instantaneous contacts in addition to the delayed contacts. Instantaneous contacts energize when input voltage is applied and remain until voltage is removed.  
 See: CT-EAS

**Accumulating time delay feature:** Some DOM/DOB timers allow the time delay to be stopped and held and then resumed by opening and closing an external switch.  
 See: CT-EAS, CT-EVS

### Delay on Make/Interval: (ProgramaCube® Function MI)

(Single Pulse Generator, Delayed Interval, Delay on Operate/Single Pulse on Operate)

**OPERATION:** Upon application of input voltage, the delay on make time delay (TD1) begins, the output remains de-energized. At the end of this delay, the output (relay or solid state) energizes and the interval delay (TD2) begins. At the end of the interval delay (TD2), the output de-energizes.  
**RESET:** Removing input voltage resets the output, the time delays and returns the sequence to the first delay.  
 See: ESD5, HRPD, KRPD, KSPD, NHPD, TRDU, CT-PGS

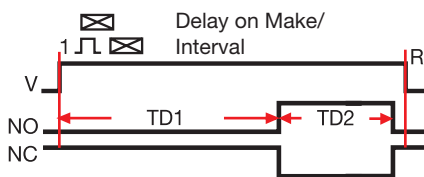

### Accumulative Delay on Make/Interval: (ProgramaCube® Function AMI)

**OPERATION:** Input voltage must be applied before and during timing. The output is de-energized before and during the TD1 time delay. Each time S1 closes, the time delay progresses; when it opens, timing stops. When the amount of time S1 is closed equals the full TD1 delay, the output (relay or solid state) energizes for TD2. Upon completion of TD2, the output relay de-energizes. Opening S1 during TD2 has no affect.  
**RESET:** Removing input voltage resets the time delay, output relay, and the sequence to the first delay.  
 See: HRPD, KRPD, KSPD, NHPD

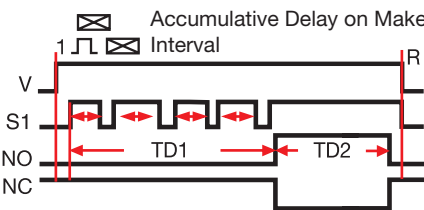

#### Legend

V = Voltage	R1 = Wye Start Relay
S1 = Initiate Switch	NO = Normally Open
TS = Start Delay	NC = Normally Closed
R = Reset	TP = 50ms Pause Delay
TD1, TD2 = Time Delay	R2 = Delta Run Relay
}}	= Undefined Time

# Timer Functions

## Two Functions in One Timer

Timer Selection

### Delay On Make/Recycle: (ProgramaCube® Function MRE)

**OPERATION:** Upon application of input voltage, TD1 begins and the output (relay or solid state) remains de-energized. At the end of TD1, the TD2 recycle function begins and the output (relay or solid state) cycles ON and OFF for equal delays. This cycle continues until input voltage is removed.

**RESET:** Removing input voltage resets the output and time delays, and returns the sequence to the first delay. See: KSPD, KRPD, NHPD, HRPD, TRDU

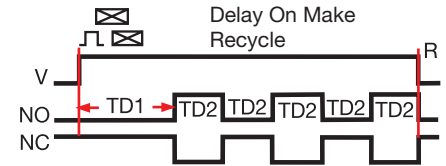

### Delay On Make/Single Shot: (ProgramaCube® Function MS)

**OPERATION:** Upon application of input voltage and the closure of S1, TD1 begins and the output (relay or solid state) remains de-energized. The output (relay or solid state) energizes at the end of TD1, and TD2 begins. At the end of TD2, the output (relay or solid state) de-energizes. Opening or reclosing S1 during timing has no effect on the time delays.

**RESET:** Reset occurs when the time delay is complete and S1 is open. Removing input voltage resets the time delay, output, and the sequence to the first delay. See: KSPD, KRPD, NHPD, HRPD, TRDU

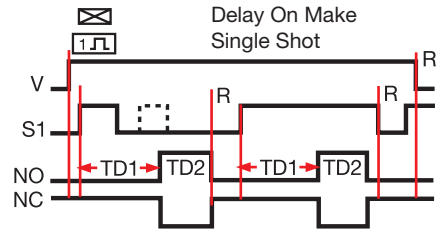

### Interval/Recycle: (ProgramaCube® Function IRE)

**OPERATION:** Upon application of input voltage TD1 begins. At the same time, the TD2 ON time begins and the output (relay or solid state) energizes. At the end of the ON time, the TD2 OFF time begins and the output de-energizes. The equal ON time OFF time cycle continues until TD1 is completed at which time the output de-energizes.

**RESET:** Removing input voltage resets the time delays, output, and the sequence to the Interval function. See: KSPD, KRPD, NHPD, HRPD, TRDU

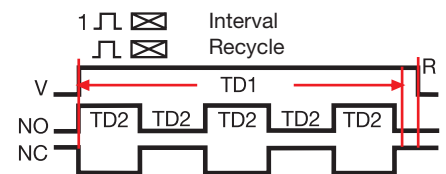

### Delay On Break/Recycle: (ProgramaCube® Function BRE)

**OPERATION:** Upon application of input voltage and the closure of S1, the TD2 ON time begins and the output (relay or solid state) energizes. Upon completion of the ON time, the output de-energizes for the TD2 OFF time. At the end of the OFF time, the equal ON/OFF cycle repeats. When S1 opens, the TD1 delay begins. TD1 and TD2 run concurrently until the completion of TD1 at which time, the TD2 ON/OFF cycle terminates and the output de-energizes. The output energizes if S1 is closed when input voltage is applied.

**RESET:** Reclosing S1 during timing resets the TD1 time delay. Removing input voltage resets the time delay, output, and the sequence to the Delay on Break function. See: KSPD, KRPD, NHPD, HRPD, TRDU

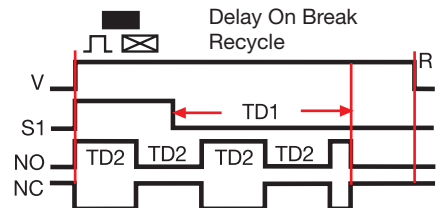

### Single Shot/Recycle: (ProgramaCube® Function SRE)

**OPERATION:** Upon application of input voltage and the closure of S1, TD1 begins. At the same time, the TD2 ON time begins and the output (relay or solid state) energizes. Upon completion of the ON time, the output de-energizes for the TD2 OFF time. At the end of the OFF time, the equal ON/OFF cycle repeats. TD1 and TD2 run concurrently until the completion of TD1 at which time, the TD2 ON/OFF cycle terminates and the output de-energizes. Opening or reclosing S1 during timing has no effect on the time delays. The output will energize if S1 is closed when input voltage is applied.

**RESET:** Removing input voltage resets the time delay, output, and the sequence to the first delay. See: HRPD, KRPD, KSPD, NHPD, TRDU

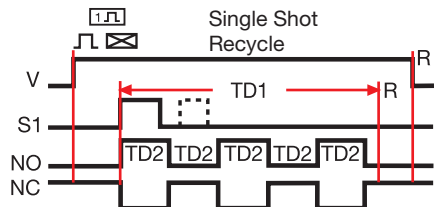

### Single Shot/Lockout: (ProgramaCube® Function SL)

**OPERATION:** Upon application of input voltage and momentary or maintained closure of S1, the output (relay or solid state) energizes and TD1 single shot time delay begins. The output relay de-energizes at the end of TD1 and the TD2 lockout time delay begins. During TD2 (and TD1) closing switch S1 has no effect on the operation. After TD2 is complete, closing S1 starts another operation. If S1 is closed when input voltage is applied, the output energizes and the TD1 time delay begins.

**RESET:** Removing input voltage resets the time delays and the output and returns the cycle to the first delay.

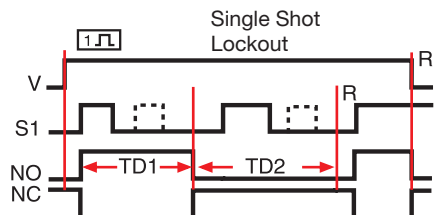

### Interval/Delay On Make: (ProgramaCube® Function IM)

**OPERATION:** Upon application of input voltage, the output (relay or solid state) energizes and TD1 begins. At the end of TD1, the output de-energizes and TD2 begins. At the end of TD2, the output energizes.

**RESET:** Removing input voltage resets the time delays, output, and the sequence to the first delay. See: HRPD, KRPD, KSPD, NHPD, TRDU

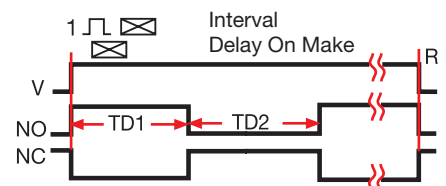

## Timer Functions

### Counting and Switching Functions

2

#### Leading edge flip-flop: (ProgramaCube® Function F)

**OPERATION:** Input voltage must be applied before and during operation. The operation begins with the output (relay or solid state) de-energized. Upon momentary or maintained closure (leading edge triggered) of the initiate switch S1, the time delay begins. At the end of the time delay, the output energizes and remains energized. Opening or re-closing S1 during timing has no affect. After the output transfers, the next closure of S1 starts a new operation. Each time an S1 closure is recognized, the time delay occurs and then the output transfers, ON to OFF, OFF to ON, ON to OFF. The first operation will occur if S1 is closed when input voltage is applied.

**RESET:** Removing input voltage resets the time delay and the output to the de-energized state.

Function can be applied to ProgramaCube Series: ERPQ, HRPS, KRPS, KSPS

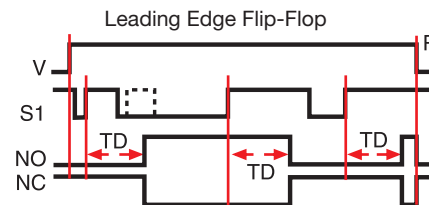

#### Alternating Relay (Trailing edge flip-flop): (ProgramaCube® Function FT)

**OPERATION:** Input voltage must be applied at all times for proper operation. The operation begins with the output (relay or solid state) de-energized. Closing S1 enables the next alternating operation. When S1 opens (trailing edge triggered), the time delay begins. At the end of the time delay, the output energizes and remains energized until S1 is (re-closed and) re-opened. Then the output relay de-energizes and remains until S1 opens again. Each time S1 opens the time delay occurs and the output transfers.

**RESET:** Removing input voltage resets the output and the time delay.

See: ARP, ERPQ, HRPS, KRPS

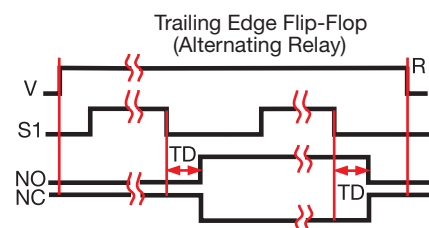

#### Counter with Pulsed Output: (ProgramaCube® Function C)

Function Limited to Switch Adjustable ProgramaCubes®

**OPERATION:** Input voltage must be applied before and during operation. Each time S1 is closed, a count is added. When the total number of S1 closures equals the total count selected on the unit, the output energizes. The output remains energized for the pulse duration specified for the product, and then de-energizes. If S1 is closed while the output is energized, a count is not added. If S1 is closed when input voltage is applied, a count is not added.

**RESET:** The unit automatically resets at the end of each operation. Removing input voltage resets the output, counter, and pulse delay.

See: HRPV, KSPU, NHPV

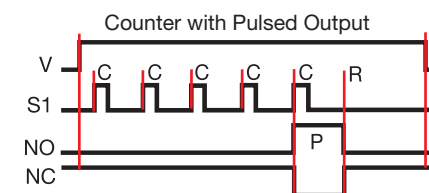

#### Counter with Interval Output: (ProgramaCube® Function CI)

Function Limited to Switch Adjustable ProgramaCubes®

**OPERATION:** Input voltage must be applied before and during operation. Each time S1 is closed, a count is added. When the total number of S1 closures equals the total count selected on the unit, the output energizes and the interval time delay begins. The output de-energizes at the end of the time delay. If S1 is closed during the time delay, a count is not added. If S1 is closed when input voltage is applied, a count is not added.

**RESET:** The counter is reset during the time delay, the unit automatically resets at the end of the interval time delay. Removing input voltage resets the output, counter, and time delay.

See: HRPV, HRV, HSPZ, KSPU, NHPV

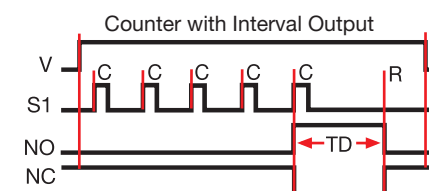

#### Legend

- V = Voltage
- R = Reset
- S1 = Initiate Switch
- TD, TD1, TD2 = Time Delay
- NO = Normally Open Contact
- NC = Normally Closed Contact
- C = Count
- P = Pulse Duration
- = Undefined Time

---

**Notes**

---



