

# Quality Cable Management

## Q-Line

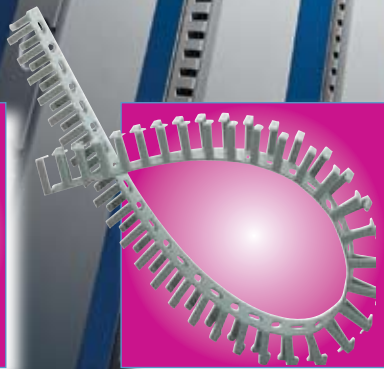

**Q-Duct**



**Q-Flex**



**Q-Tie**



**Q-Wrap**





# Cable management systems

## Index

• Alphanumeric .....	II
<b>Q-Duct</b>	
• General information .....	1
• Catalog number explanation .....	1
• Standard 8-12mm slot .....	2
• High density 4-6mm slot .....	3
• Tools & accessories .....	4
• Wiring duct cutters .....	5
• Technical data .....	6
• Wire capacity 18-750 AWG .....	7
• Wire capacity 800-1000 AWG .....	8
• Dimensions .....	9
• Part number cross reference .....	10-11
<b>Q-Flex</b>	
• Flexible wiring duct .....	13
<b>Q-Wrap</b>	
• Spiral wrap .....	15
<b>Q-Ties</b>	
• Features & applications .....	17
• Cable ties .....	18
• Accessories .....	19
• Technical data & dimensions .....	20-22

# Alphanumeric

## Q12P164C – XUS002519

Catalog No.	Page No.	Catalog No.	Page No.	Catalog No.	Page No.	Catalog No.	Page No.	Catalog No.	Page No.
Q12P164C	15	QD225X300HW	3	QDC300G	4	QT550-14BB	18		
Q12SEP164	15	QD225X300SG	2	QDC300W	4	QT550-10W	18		
Q24SEP82	15	QD225X300SW	2	QDC400G	4	QT550-10WB	18		
Q25P82C	15	QD225X400HG	3	QDC400W	4	QT625-10B	18		
Q39P82C	15	QD225X400HW	3	QDC475G	4	QT625-10BB	18		
Q39SEP82	15	QD225X400SG	2	QDC475W	4	QT625-10W	18		
Q47P82C	15	QD225X400SW	2	QDC600G	4	QT625-10WB	18		
Q47SEP82	15	QD300X150HG	3	QDC600W	4	QT700-17W	18		
QD050X050SW	2	QD300X150HW	3	QDCUTR	4	QT700-17B	18		
QD050X050HG	3	QD300X150SG	2	QDF050X050W	13	QT700-24B	18		
QD050X050HW	3	QD300X150SW	2	QDF058X058W	13	QT700-35B	18		
QD050X050SG	2	QD300X225HG	3	QDF075X075W	13	QT800-14B	18		
QD100X125HG	3	QD300X225HW	3	QDF100X100W	13	QT800-14BB	18		
QD100X125HW	3	QD300X225SG	2	QDF150X150W	13	QT800-14W	18		
QD100X125SG	2	QD300X225SW	2	QDF175X175W	13	QT800-14WB	18		
QD100X125SW	2	QD300X300HG	3	QDF200X200W	13	QT800-30B	18		
QD100X150HG	3	QD300X300HW	3	QDPDB	4	QT800-30W	18		
QD100X150HW	3	QD300X300SG	2	QDPL8-12-S	4	QTAB-B	19		
QD100X150SG	2	QD300X300SW	2	QDPR4MM	4	QTAB-C	19		
QD100X150SW	2	QD300X400HG	3	QDPR6MM	4	QTCTR	19		
QD100X225HG	3	QD300X400HW	3	QDRCD100B	4	QTOCTCTR	19		
QD100X225HW	3	QD300X400SG	2	QDRCD150B	4	QTP-INB	19		
QD100X225SG	2	QD300X400SW	2	QDRCD225B	4	QTSMB	19		
QD100X225SW	2	QD400X150HG	3	QDRCD300B	4	QTSMB-B	19		
QD100X300HG	3	QD400X150HW	3	QDRCD400B	4	QTSMB-C	19		
QD100X300HW	3	QD400X150SG	2	QDRCD500B	4	XUS001628	5		
QD100X300SG	2	QD400X150SW	2	QDRCD600B	4	XUS001629	5		
QD100X300SW	2	QD400X225HG	3	QDRVTGUN	4	XUS002518	5		
QD100X400HG	3	QD400X225HW	3	QDWS8-12-150B	4	XUS002519	5		
QD100X400HW	3	QD400X225SG	2	QDWS8-12-225B	4				
QD100X400SG	2	QD400X225SW	2	QDWS8-12-300	4				
QD100X400SW	2	QD400X300HG	3	QDWS8-12-400	4				
QD150X125SG	2	QD400X300HW	3	QT-10	13				
QD150X150HG	3	QD400X300SG	2	QT1050-35B	18				
QD150X150HW	3	QD400X300SW	2	QT1100-14B	18				
QD150X150SG	2	QD400X400HG	3	QT1100-14W	18				
QD150X150SW	2	QD400X400HW	3	QT1100-17B	18				
QD150X125HG	3	QD400X400SG	2	QT1100-17W	18				
QD150X125HW	3	QD400X400SW	2	QT1100-30B	18				
QD150X125SW	2	QD475X150HG	3	QT1100-30W	18				
QD150X225HG	3	QD475X150HW	3	QT1400-17B	18				
QD150X225SG	2	QD475X150SG	2	QT1400-17W	18				
QD150X225SW	2	QD475X150SW	2	QT1400-30B	18				
QD150X300HG	3	QD475X225HG	3	QT1400-30W	18				
QD150X300HW	3	QD475X225HW	3	QT1400-35B	18				
QD150X300SG	2	QD475X225SG	2	QT1700-35B	18				
QD150X300SW	2	QD475X225SW	2	QT1700-35W	18				
QD150X400HG	3	QD475X300HG	3	QT-20	13				
QD150X400HW	3	QD475X300HW	3	QT2150-35B	18				
QD150X400SG	2	QD475X300SG	2	QT2150-35W	18				
QD150X400SW	2	QD475X300SW	2	QT-30	13				
QD150X225HW	3	QD600X400HG	4	QT3075-35B	18				
QD225X125HG	3	QD600X400HW	3	QT3075-35W	18				
QD225X125HW	3	QD600X400SG	2	QT-40	13				
QD225X125SG	2	QD600X400SW	2	QT400-10B	18				
QD225X125SW	2	QDAT6MMX50M	4	QT400-10BB	18				
QD225X150HG	3	QDAT9MMX50M	4	QT400-10WB	18				
QD225X150HW	3	QDC050G	4	QT400-24B	18				
QD225X150SG	2	QDC050W	4	QT400-10W	18				
QD225X150SW	2	QDC100G	4	QT450-35B	18				
QD225X225HG	3	QDC100W	4	QT525-10B	18				
QD225X225HW	3	QDC150G	4	QT525-10BB	18				
QD225X225SG	2	QDC150W	4	QT525-10W	18				
QD225X225SW	2	QDC225G	4	QT525-10WB	18				
QD225X300HG	3	QDC225W	4	QT550-14B	18				

# Q-Duct wiring duct



## Q-Duct Wiring duct

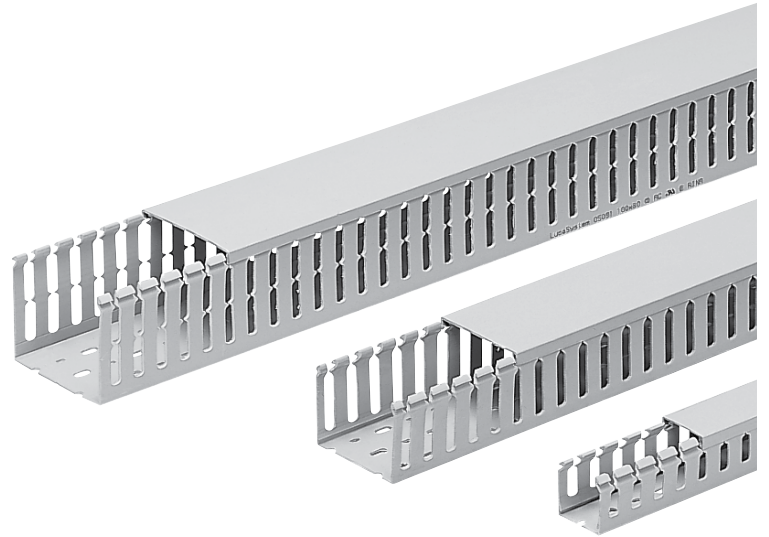

### General information

ABB offers Q-Duct, a wide variety of wire duct and accessories. Bases are available in six different width sizes and heights from 17mm to 100mm (.67" to 3.94"). Top profile of the ribs of all wiring duct have been redesigned to make the cover easier to open and close. The new rounded shape prevents abrasions to the installer's hands. The scoreline at the base of each finger enables a clean break to create an opening to run wires through. ABB wiring duct is used in applications with rated voltage of up to 1000 VAC and 1500 VDC.

### Catalog number explanation

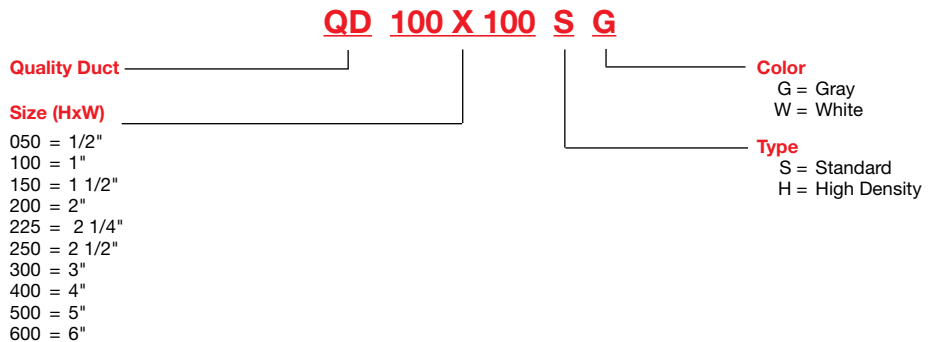

**Q-Duct**  
Standard, 8-12mm slot

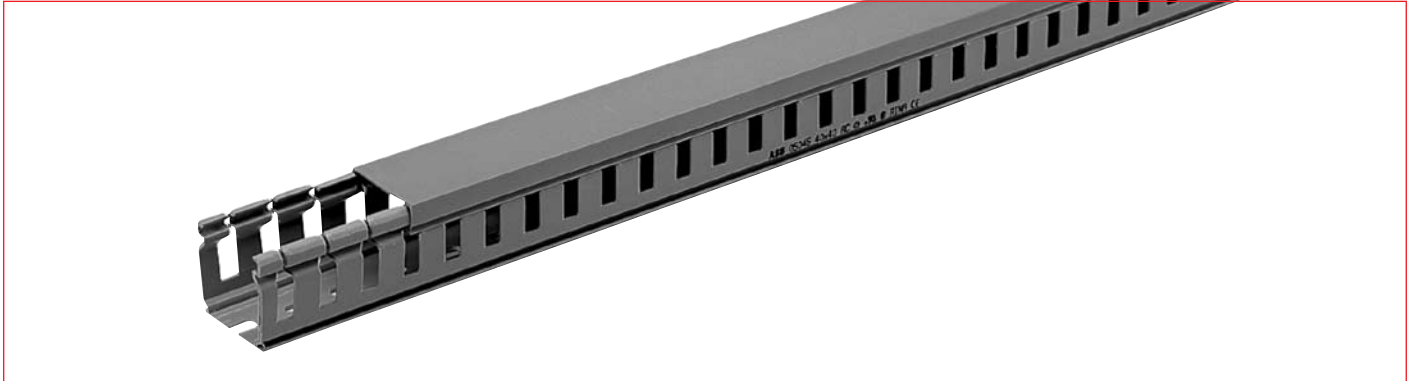

Dimensions WXH (in)	White	Gray	Dimensions WXH (mm)	Feet per package	Meters per package	Pieces per package
	Standard 8-12mm Slot Catalog number	Standard 8-12mm Slot Catalog number				
1/2 X 5/8	QD050X050SW	QD050X050SG	15 x 17	151	46	23
1 X 1¼	QD100X125SW	QD100X125SG	25 x 30	190.5	58	29
1½ X 1¼	QD150X125SW	QD150X125SG	40 x 30	131.5	40	20
2¼ X 1¼	QD225X125SW	QD225X125SG	60 x 30	171	52	26
1 x 1½	QD100X150SW	QD100X150SG	25 x 40	157.5	48	24
1½ x 1½	QD150X150SW	QD150X150SG	40 x 40	98.5	30	15
2¼ x 1½	QD225X150SW	QD225X150SG	60 x 40	131	40	20
3 x 1½	QD300X150SW	QD300X150SG	80 x 40	105	32	16
4 x 1½	QD400X150SW	QD400X150SG	100 x 40	79	24	12
4¾ x 1½	QD475X150SW	QD475X150SG	120 x 40	66	20	10
1 x 2¼	QD100X225SW	QD100X225SG	25 x 60	111.5	34	17
1½ x 2¼	QD150X225SW	QD150X225SG	40 x 60	72	22	11
2¼ x 2¼	QD225X225SW	QD225X225SG	60 x 60	105	32	16
3 x 2¼	QD300X225SW	QD300X225SG	80 x 60	79	24	12
4 x 2¼	QD400X225SW	QD400X225SG	100 x 60	66	20	10
4¾ x 2¼	QD475X225SW	QD475X225SG	120 x 60	46	14	7
1 x 3	QD100X300SW	QD100X300SG	25 x 80	92	28	14
1½ x 3	QD150X300SW	QD150X300SG	40 x 80	118	36	18
2¼ x 3	QD225X300SW	QD225X300SG	60 x 80	79	24	12
3 x 3	QD300X300SW	QD300X300SG	80 x 80	52	16	8
4 x 3	QD400X300SW	QD400X300SG	100 x 80	52	16	8
4¾ x 3	QD475X300SW	QD475X300SG	120 x 80	39	12	6
1 x 4	QD100X400SW	QD100X400SG	25 x 100	65.5	20	10
1½ x 4	QD150X400SW	QD150X400SG	40 x 100	92	28	14
2¼ x 4	QD225X400SW	QD225X400SG	60 x 100	66	20	10
3 x 4	QD300X400SW	QD300X400SG	80 x 100	46	14	7
4 x 4	QD400X400SW	QD400X400SG	100 x 100	26	8	4
6 x 4	QD600X400SW	QD600X400SG	150 x 100	26	8	4

Sold in package quantity only. Order quantity must be equal to quantity shown in "Piece per package" column. Wire duct cover included.

# Q-Duct

## High density, 4-6mm slot

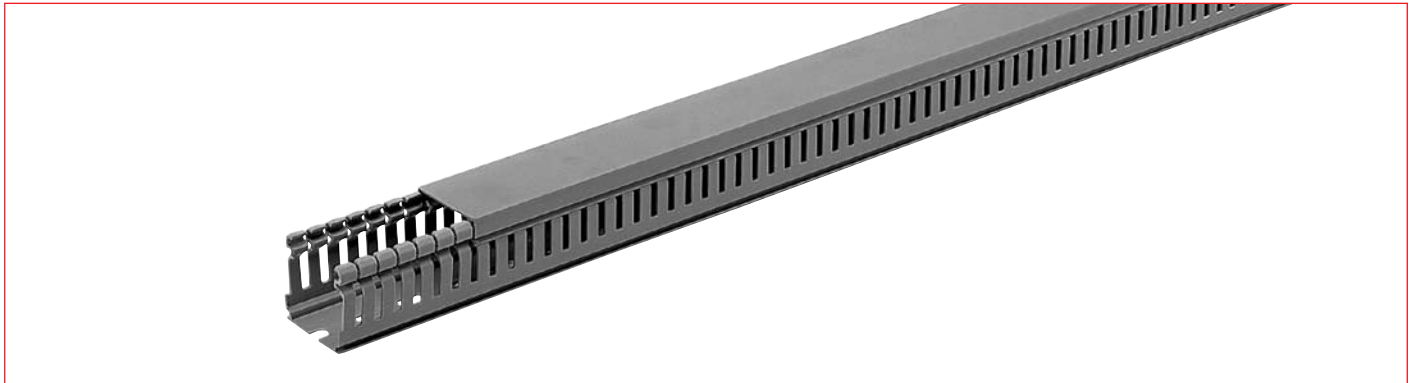

Dimensions WXH (in)	White High Density 4-6mm Slot	Gray High Density 4-6mm Slot	Dimensions WXH (mm)	Feet per package	Meters per package	Pieces per package
1/2 x 5/8	QD050X050HW	QD050X050HG	15 x 17	151	46	23
1 x 1 1/4	QD100X125HW	QD100X125HG	25 x 30	190.5	58	29
1 1/2 x 1 1/4	QD150X125HW	QD150X125HG	40 x 30	131.5	40	20
2 1/4 x 1 1/4	QD225X125HW	QD225X125HG	60 x 30	171	52	26
1 x 1 1/2	QD100X150HW	QD100X150HG	25 x 40	157.5	48	24
1 1/2 x 1 1/2	QD150X150HW	QD150X150HG	40 x 40	98.5	30	15
2 1/4 x 1 1/2	QD225X150HW	QD225X150HG	60 x 40	131	40	20
3 x 1 1/2	QD300X150HW	QD300X150HG	80 x 40	105	32	16
4 x 1 1/2	QD400X150HW	QD400X150HG	100 x 40	79	24	12
4 3/4 x 1 1/2	QD475X150HW	QD475X150HG	120 x 40	66	20	10
1 x 2 1/4	QD100X225HW	QD100X225HG	25 x 60	111.5	34	17
1 1/2 x 2 1/4	QD150X225HW	QD150X225HG	40 x 60	72	22	11
2 1/4 x 2 1/4	QD225X225HW	QD225X225HG	60 x 60	105	32	16
3 x 2 1/4	QD300X225HW	QD300X225HG	80 x 60	79	24	12
4 x 2 1/4	QD400X225HW	QD400X225HG	100 x 60	66	20	10
4 3/4 x 2 1/4	QD475X225HW	QD475X225HG	120 x 60	46	14	7
1 x 3	QD100X300HW	QD100X300HG	100 x 80	92	28	14
1 1/2 x 3	QD150X300HW	QD150X300HG	40 x 80	118	36	18
2 1/4 x 3	QD225X300HW	QD225X300HG	60 x 80	79	24	12
3 x 3	QD300X300HW	QD300X300HG	80 x 80	52	16	8
4 x 3	QD400X300HW	QD400X300HG	100 x 80	52	16	8
4 3/4 x 3	QD475X300HW	QD475X300HG	120 x 80	39	12	6
1 x 4	QD100X400HW	QD100X400HG	25 x 100	65.5	20	10
1 1/2 x 4	QD150X400HW	QD150X400HG	40 x 100	92	28	14
2 1/4 x 4	QD225X400HW	QD225X400HG	60 x 100	66	20	10
3 x 4	QD300X400HW	QD300X400HG	80 x 100	46	14	7
4 x 4	QD400X400HW	QD400X400HG	100 x 100	26	8	4
6 x 4	QD600X400HW	QD600X400HG	150 x 100	26	8	4

Sold in package quantity only. Order quantity must be equal to quantity shown in "Piece per package" column. Wire duct cover included.

## Q-Duct Tools and accessories

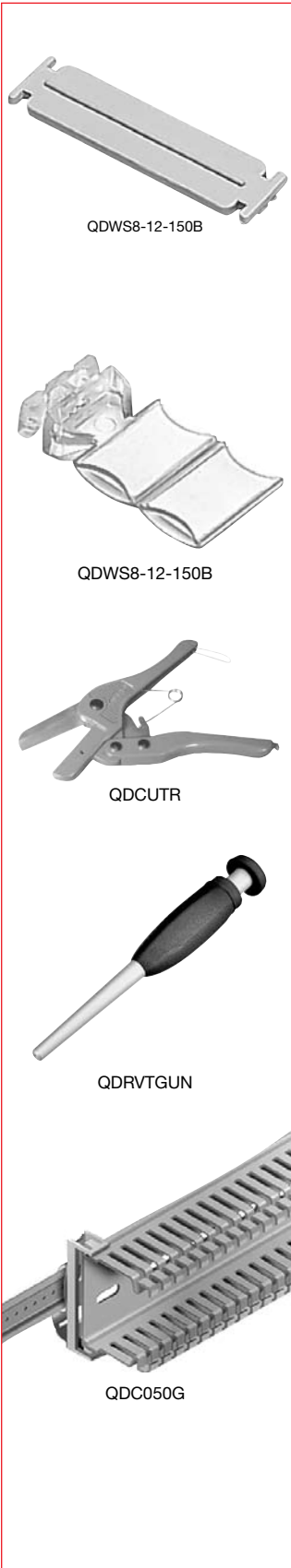

Item	Catalog number	Pieces per package
Adhesive tape 6mm wide x 50m long	QDAT6MMX50M	1
Adhesive tape 9mm wide x 50m long	QDAT9MMX50M	1
Plastic rivet, 4mm (to be used with plastic duct base)	QDPR4MM	100
Plastic rivet, 6mm (to be used with plastic duct base)	QDPR6MM	100
Plastic duct base	QDPDB	100
Plastic wire stops for 8-12mm slot 40mm base	QDWS8-12-150B	100
Plastic wire stops for 8-12mm slot 60mm base	QDWS8-12-225B	100
Plastic wire stops for 8-12mm slot 80mm base	QDWS8-12-300	100
Plastic wire stops for 8-12mm slot 100mm base	QDWS8-12-400	100
Plastic label for 8-12mm slot	QDPL8-12-S	100
Rapid clip for DIN rail for 25mm base	QDRCD100B	20
Rapid clip for DIN rail for 40mm base	QDRCD150B	20
Rapid clip for DIN rail for 60mm base	QDRCD225B	20
Rapid clip for DIN rail for 80mm base	QDRCD300B	20
Rapid clip for DIN rail for 100mm base	QDRCD400B	20
Rapid clip for DIN rail for 120mm base	QDRCD500B	20
Rapid clip for DIN rail for 150mm base	QDRCD600B	20
Wire duct hand cutting tool	QDCUTR	1
Rivet gun	QDRVTGUN	1

Item	Dimensions width (mm)	Catalog number	Feet per package	Meters per package	Pieces per package
<b>Gray wiring duct covers</b>					
1/2"	15	QDC050G	656	200	100
1"	25	QDC100G	197	60	30
1 1/2"	40	QDC150G	131	40	20
2 1/4"	60	QDC225G	79	24	12
3"	80	QDC300G	52	16	8
4"	100	QDC400G	157	48	24
4 3/4"	120	QDC475G	118	36	18
6"	150	QDC600G	92	28	14
<b>White wiring duct covers</b>					
1/2"	15	QDC050W	656	200	100
1"	25	QDC100W	197	60	30
1 1/2"	40	QDC150W	131	40	20
2 1/4"	60	QDC225W	79	24	12
3"	80	QDC300W	52	16	8
4"	100	QDC400W	157	48	24
4 3/4"	120	QDC475W	118	36	18
6"	150	QDC600W	92	28	14

NOTE: Sold in package quantity only. Order quantity must be equal quantity shown in "Pieces per package" column.  
EX: For QDPDB, 100 pieces must be ordered to get package quantity.

## Q-Duct Wiring duct cutter Industrial & production grade

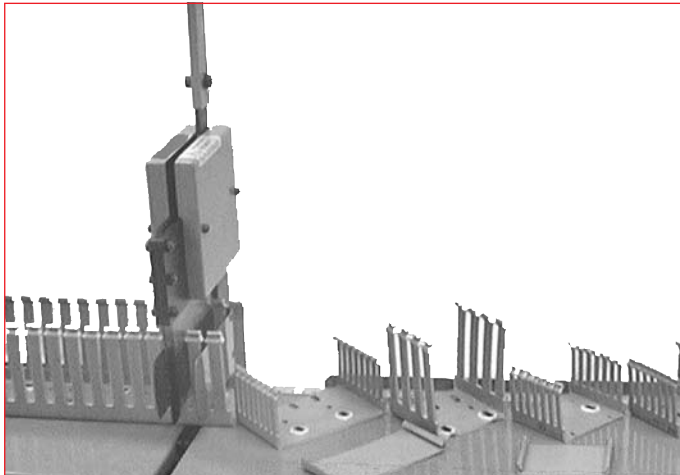

Production grade

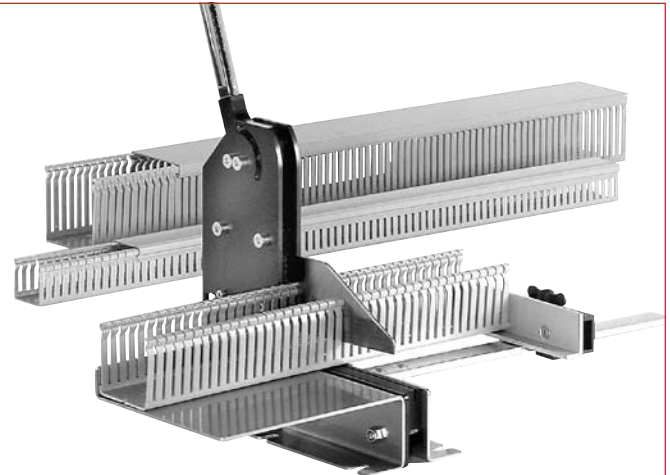

Industrial grade

### Industrial grade

Description	Catalog number
Wire duct cutting machine - Industrial grade	XUS001628
Replacement blade	XUS001629

### Technical Features

- Length: 1450 mm
- Height: 950 mm
- Depth: 260 mm
- Blade length: 130 mm (maximum wire duct cutting width is 120 mm (5.0 in))
- Blade life: 250,000 cuts
- Blade life is based on usage of traditional PVC wiring duct. Use of halogen-free wiring or any other wiring duct containing abrasive material dramatically reduces the blade life
- Bench mounting material not included.

### Production grade

Description	Catalog number
Wire duct cutting machine - Production grade	XUS002518
Replacement blade	XUS002519

### Technical Features

- Length: 1290 mm
- Height: 785 mm
- Depth: 285 mm
- Blade length: 136 mm (maximum wire duct cutting width is 120 mm (5.0 in))
- Blade life: 400,000 cuts
- Blade life is based on usage of traditional PVC wiring duct. Use of halogen-free wiring or any other wiring duct containing abrasive material dramatically reduces the blade life
- Calibrated scale
- Bench mounting material not included.

## Q-Duct Resistance to chemical agents Technical data

### Resistance to chemical agents

Chemical	Concentration	Temp. °C	Resistance
Acetic acid, hydrous	10%	50	①
Acetic acid*	60%	50	①
Acetone	Traces	20	②
Acetone	100%	20	②
Acqua regia		20	①
Ammonia concentrate	88%	50	①
Ammonia, dry gas	100%	50	①
Ammonia, liquid	100%	20	③
Aniline, pure	100%	20	②
Arsenic acid, hydrous	concentrated	20	①
Barium hydroxide, hydr.	—	50	①
Beer	commercial	20	①
Benzene	—	20	②
Benzoic acid	—	20	③
Borax, hydrous	thinned	50	①
Boric acid, hydrous	thinned	50	①
Brandy	commercial	20	①
Bromide liquid	—	20	②
Butane gaseous	—	20	①
Butadiene	50%	50	①
Butanol	—	20	①
Butyric acid, hydrous	20%	20	①
Calcium chloride	—	50	①
Camphor oil	—	20	①
Carbon tetrachloride	—	20	③
Chlorine gaseous, dry	100%	20	①
Chlorine gaseous, moist	20%	20	③
Chlorine water	saturated	20	③
Chromic acid, hydrous	—	50	①
Citric acid, hydrous	—	50	①
Copper sulphate, hydrous	thinned	50	①
Diesel oil	—	20	①
Ethyl-alcohol	100% (in water)	20	①
Formaldehyde, hydrous	40%	50	①

Chemical	Concentration	Temp. °C	Resistance
Formic acid	100%	20	①
Freon 12	—	20	①
Gasoline	—	50	①
Glycerine, hydrous	—	50	①
Hydrochloric acid	saturated	50	①
Hydrogen	—	50	①
Linseed oil	—	50	①
Lubricating oils	—	50	①
Mineral oil	—	50	①
Molasses	—	20	④
Oils and fats	commercial	50	①
Oil of turpentine	commercial	20	①
Ozone	—	20	①
Paraffin wax	—	50	①
Photographic developer	commercial	50	①
Photographic emulsions	—	50	①
Potassium permanganate	6%	20	①
Propane, liquid	—	20	①
Salicylic acid	—	50	①
Sea water	—	50	①
Soda, hydrous	saturated	50	①
Sodium chloride	thinned	50	①
Spirits, all types	—	20	①
Sulphur	—	50	①
Sulphuric acid, hydrous	40%	50	①
Tannic acid	—	50	①
Tetrahydrofuran	—	20	②
Toluene	—	20	②
Urea, hydrous	—	50	①
Urine	—	50	①
Vinegar	commercial	50	①
Water	—	50	①
Wines, red & white	commercial	20	①
Zinc sulphate, hydrous	thinned	50	①

### Technical data

- Gray color - RAL 7030
- White color - RAL 9016
- Plastic insulating, shock-proof, self-extinguishing material in compliance with UL 94 VO Standard and resistant to abnormal heat and fire up to 960° (glow wire test) in compliance with IEC 695-2-1 Standard. UL File # E125800
- Minimum storage/transport temperature -5°C
- Minimum installation and usage temperature -15°C
- Maximum usage temperature +60°C
- Resistance to acids, oils and greases



# Q-Duct Wire capacity 18-750 AWG

Q-Line  
Cable Management  
Systems

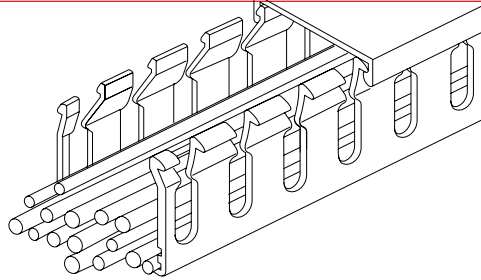

## 18 - 1 AWG

Gray 4/6 slot	Gray 8/12 slot	White 4/6 slot	White 8/12 slot	Size (mm)	Maximum number of wires according to AWG & mm <sup>2</sup>													
					Size (inches)	Areas (mm <sup>2</sup> )	18 0.82	16 1.3	14 2.1	12 3.3	10 5.3	8 6.4	6 13.3	4 21.2	3 26.7	2 33.6	1 42.4	
QD050X050HG	QD050X050SG	QD050X050HW	QD050X050SW	15x17	1/2x5/8	110	67	42	26	16	10	6	4	2	2	1	1	
QD100X125HG	QD100X125SG	QD100X125HW	QD100X125SW	25x30	1x11/4	490	298	188	116	74	46	29	18	11	9	7	5	
QD150X125HG	QD150X125SG	QD150X125HW	QD150X125SW	40x30	1 1/2x1 1/4	890	542	342	211	134	83	52	33	20	16	13	10	
QD225X125HG	QD225X125SG	QD225X125HW	QD225X125SW	60x30	2 1/4x1 1/4	1430	871	550	340	216	134	85	53	33	26	21	16	
QD100X150HG	QD100X150SG	QD100X150HW	QD100X150SW	25x40	1x1 1/2	710	432	273	169	107	66	42	26	16	13	10	8	
QD150X150HG	QD150X150SG	QD150X150HW	QD150X150SW	40x40	1 1/2x1 1/2	1260	768	484	300	190	118	75	47	29	23	18	14	
QD225X150HG	QD225X150SG	QD225X150HW	QD225X150SW	60x40	2 1/4x1 1/2	2000	1219	769	476	303	188	119	75	47	37	29	23	
QD300X150HG	QD300X150SG	QD300X150HW	QD300X150SW	80x40	3x1 1/2	2710	1652	1042	645	410	255	161	101	63	50	40	31	
QD400X150HG	QD400X150SG	QD400X150HW	QD400X150SW	100x40	4x1 1/2	3460	2109	1330	823	524	326	205	130	81	64	51	40	
QD475X150HG	QD475X150SG	QD475X150HW	QD475X150SW	120x40	4 3/4x1 1/2	4200	2560	1615	1000	636	396	250	157	99	78	62	49	
QD100X225HG	QD100X225SG	QD100X225HW	QD100X225SW	25x60	1 x 2 1/4	1120	682	430	266	169	105	66	42	26	20	16	13	
QD150X225HG	QD150X225SG	QD150X225HW	QD150X225SW	40x60	1 1/2x2 1/4	1970	1201	757	469	298	185	117	74	46	36	29	23	
QD225X225HG	QD225X225SG	QD225X225HW	QD225X225SW	60x60	2 1/4x2 1/4	3060	1865	1176	728	463	288	182	115	72	57	45	36	
QD300X225HG	QD300X225SG	QD300X225HW	QD300X225SW	80x60	3x2 1/4	4190	2554	1611	997	634	395	249	157	98	78	62	49	
QD400X225HG	QD400X225SG	QD400X225HW	QD400X225SW	100x60	4x2 1/4	5320	3243	2046	1266	806	501	316	200	125	99	79	62	
QD475X225HG	QD475X225SG	QD475X225HW	QD475X225SW	120x60	4 3/4x2 1/4	6330	3859	2434	1507	959	597	376	237	149	118	94	74	
QD100X300HG	QD100X300SG	QD100X300HW	QD100X300SW	25x80	1x3	1540	939	592	366	233	145	91	57	36	28	22	18	
QD150X300HG	QD150X300SG	QD150X300HW	QD150X300SW	40x80	1 1/2x3	2670	1628	1026	635	404	251	158	100	62	50	39	31	
QD225X300HG	QD225X300SG	QD225X300HW	QD225X300SW	60x80	2 1/4x3	4140	2524	1592	985	627	390	246	155	97	77	61	48	
QD300X300HG	QD300X300SG	QD300X300HW	QD300X300SW	80x80	3x3	5650	3445	2173	1345	856	533	336	212	133	105	84	66	
QD400X300HG	QD400X300SG	QD400X300HW	QD400X300SW	100x80	4x3	7170	4371	2757	1707	1086	676	426	269	169	134	106	84	
QD475X300HG	QD475X300SG	QD475X300HW	QD475X300SW	120x80	4 3/4x3	8570	5225	3296	2040	1298	808	510	322	202	160	127	101	
QD100X400HG	QD100X400SG	QD100X400HW	QD100X400SW	25x100	1x4	1970	1201	757	469	298	185	117	74	46	36	29	23	
QD150X400HG	QD150X400SG	QD150X400HW	QD150X400SW	40x100	1 1/2x4	3410	2079	1311	811	516	321	202	128	80	63	50	40	
QD225X400HG	QD225X400SG	QD225X400HW	QD225X400SW	60x100	2 1/4x4	5300	3231	2038	1261	803	500	315	199	125	99	78	62	
QD300X400HG	QD300X400SG	QD300X400HW	QD300X400SW	80x100	3x4	7190	4384	2765	1711	1089	678	427	270	169	134	106	84	
QD400X400HG	QD400X400SG	QD400X400HW	QD400X400SW	100x100	4x4	9110	5554	3503	2169	1380	859	542	342	214	170	135	107	
QD600X400HG	QD600X400SG	QD600X400HW	QD600X400SW	150x100	6x4	13,740	8378	5284	3271	2081	1296	817	516	324	257	204	162	

## 1/0 - 750 AWG

Gray 4/6 slot	Gray 8/12 slot	White 4/6 slot	White 8/12 slot	Size (mm)	Maximum number of wires according to AWG & mm <sup>2</sup>													
					Size (inches)	Areas (mm <sup>2</sup> )	1/0 53.5	2/0 67.4	3/0 85	4/0 107.2	250 127	300 152	350 177	400 203	500 253	600 304	750 380	
QD050X050HG	QD050X050SG	QD050X050HW	QD050X050SW	15x17	1/2x5/8	110	1	0	0	0	0	0	0	0	0	0	0	
QD100X125HG	QD100X125SG	QD100X125HW	QD100X125SW	25x30	1x1 1/4	490	4	3	2	2	1	1	1	1	1	1	1	
QD150X125HG	QD150X125SG	QD150X125HW	QD150X125SW	40x30	1 1/2x1 1/4	890	8	6	5	4	3	2	2	2	1	1	1	
QD225X125HG	QD225X125SG	QD225X125HW	QD225X125SW	60x30	2 1/4x1 1/4	1430	13	10	8	6	5	4	4	3	2	2	1	
QD100X150HG	QD100X150SG	QD100X150HW	QD100X150SW	25x40	1x1 1/2	710	6	5	4	3	2	2	1	1	1	1	0	
QD150X150HG	QD150X150SG	QD150X150HW	QD150X150SW	40x40	1 1/2x1 1/2	1260	11	9	7	5	4	4	3	3	2	2	1	
QD225X150HG	QD225X150SG	QD225X150HW	QD225X150SW	60x40	2 1/4x1 1/2	2000	18	14	11	9	7	6	5	4	3	3	2	
QD300X150HG	QD300X150SG	QD300X150HW	QD300X150SW	80x40	3x1 1/2	2710	25	20	15	12	10	8	7	6	5	4	3	
QD400X150HG	QD400X150SG	QD400X150HW	QD400X150SW	100x40	4x1 1/2	3460	32	25	20	16	13	11	9	8	6	5	4	
QD475X150HG	QD475X150SG	QD475X150HW	QD475X150SW	120x40	4 3/4x1 1/2	4200	39	31	24	19	16	13	11	10	8	6	5	
QD100X225HG	QD100X225SG	QD100X225HW	QD100X225SW	25x60	1x2 1/4	1120	10	8	6	5	4	3	3	2	2	1	1	
QD150X225HG	QD150X225SG	QD150X225HW	QD150X225SW	40x60	1 1/2x2 1/4	1970	18	14	11	9	7	6	5	4	3	3	2	
QD225X225HG	QD225X225SG	QD225X225HW	QD225X225SW	60x60	2 1/4x2 1/4	3060	28	22	18	14	12	10	8	7	6	5	4	
QD300X225HG	QD300X225SG	QD300X225HW	QD300X225SW	80x60	3x2 1/4	4190	39	31	24	19	16	13	11	10	8	6	5	
QD400X225HG	QD400X225SG	QD400X225HW	QD400X225SW	100x60	4x2 1/4	5320	49	39	31	24	20	17	15	13	10	8	7	
QD475X225HG	QD475X225SG	QD475X225HW	QD475X225SW	120x60	4 3/4x2 1/4	6330	59	46	37	29	24	20	17	15	12	10	8	
QD100X300HG	QD100X300SG	QD100X300HW	QD100X300SW	25x80	1x3	1540	14	11	9	7	6	5	4	3	3	2	2	
QD150X300HG	QD150X300SG	QD150X300HW	QD150X300SW	40x80	1 1/2x3	2670	24	19	15	12	10	8	7	6	5	4	3	
QD225X300HG	QD225X300SG	QD225X300HW	QD225X300SW	60x80	2 1/4x3	4140	38	30	24	19	16	13	11	10	8	6	5	
QD300X300HG	QD300X300SG	QD300X300HW	QD300X300SW	80x80	3x3	5650	52	41	33	26	22	18	15	13	11	9	7	
QD400X300HG	QD400X300SG	QD400X300HW	QD400X300SW	100x80	4x3	7170	67	53	42	33	28	23	20	17	14	11	9	
QD475X300HG	QD475X300SG	QD475X300HW	QD475X300SW	120x80	4 3/4x3	8570	80	63	50	39	33	28	24	21	16	14	11	
QD100X400HG	QD100X400SG	QD100X400HW	QD100X400SW	25x100	1x4	1970	18	14	11	9	7	6	5	4	3	3	2	
QD150X400HG	QD150X400SG	QD150X400HW	QD150X400SW	40x100	1 1/2x4	3410	31	25	20	15	13	11	9	8	6	5	4	
QD225X400HG	QD225X400SG	QD225X400HW	QD225X400SW	60x100	2 1/4x4	5300	49	39	31	24	20	17	14	13	10	8	6	
QD300X400HG	QD300X400SG	QD300X400HW	QD300X400SW	80x100	3x4	7190	67	53	42	33	28	23	20	17	14	11	9	
QD400X400HG	QD400X400SG	QD400X400HW	QD400X400SW	100x100	4x4	9110	85	67	53	42	35	29	25	22	18	14	11	

## Q-Duct

### Wire capacity 800-1000 AWG

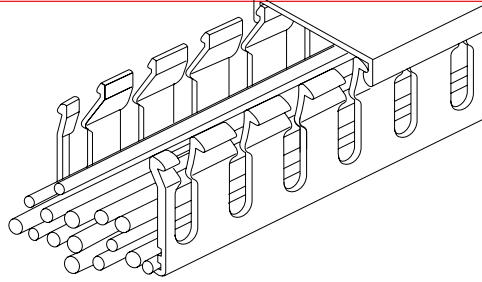

#### 800 - 1000 AWG

Gray 4/6 slot	Gray 8/12 slot	White 4/6 slot	White 8/12 slot	Nominal size (mm)	Nominal size (inches)	Usable areas (mm <sup>2</sup> )	Maximum number of wires according to AWG and cable section (mm <sup>2</sup> )	
							800 405	1000 508
QD050X050HG	QD050X050SG	QD050X050HW	QD050X050SW	15x17	1/2x5/8	110	0	0
QD100X125HG	QD100X125SG	QD100X125HW	QD100X125SW	25x30	1x1¼	490	0	0
QD150X125HG	QD150X125SG	QD150X125HW	QD150X125SW	40x30	1½x1¼	890	1	0
QD225X125HG	QD225X125SG	QD225X125HW	QD225X125SW	60x30	2¼x1¼	1430	1	1
QD100X150HG	QD100X150SG	QD100X150HW	QD100X150SW	25x40	1x1½	710	0	0
QD150X150HG	QD150X150SG	QD150X150HW	QD150X150SW	40x40	1½x1½	1260	1	1
QD225X150HG	QD225X150SG	QD225X150HW	QD225X150SW	60x40	2¼x1½	2000	2	1
QD300X150HG	QD300X150SG	QD300X150HW	QD300X150SW	80x40	3x1½	2710	3	2
QD400X150HG	QD400X150SG	QD400X150HW	QD400X150SW	100x40	4x1½	3460	4	3
QD475X150HG	QD475X150SG	QD475X150HW	QD475X150SW	120x40	4¾x1½	4200	5	4
QD100X225HG	QD100X225SG	QD100X225HW	QD100X225SW	25x60	1 x 2¼	1120	1	—
QD150X225HG	QD150X225SG	QD150X225HW	QD150X225SW	40x60	1½x2¼	1970	2	1
QD225X225HG	QD225X225SG	QD225X225HW	QD225X225SW	60x60	2¼x2¼	3060	3	3
QD300X225HG	QD300X225SG	QD300X225HW	QD300X225SW	80x60	3x2¼	4190	5	4
QD400X225HG	QD400X225SG	QD400X225HW	QD400X225SW	100x60	4x2¼	5320	6	5
QD475X225HG	QD475X225SG	QD475X225HW	QD475X225SW	120x60	4¾x2¼	6330	7	6
QD100X300HG	QD100X300SG	QD100X300HW	QD100X300SW	25x80	1x3	1540	1	—
QD150X300HG	QD150X300SG	QD150X300HW	QD150X300SW	40x80	1½x3	2670	3	2
QD225X300HG	QD225X300SG	QD225X300HW	QD225X300SW	60x80	2¼x3	4140	5	4
QD300X300HG	QD300X300SG	QD300X300HW	QD300X300SW	80x80	3x3	5650	6	5
QD400X300HG	QD400X300SG	QD400X300HW	QD400X300SW	100x80	4x3	7170	8	7
QD475X300HG	QD475X300SG	QD475X300HW	QD475X300SW	120x80	4¾x3	8570	10	8
QD100X400HG	QD100X400SG	QD100X400HW	QD100X400SW	25x100	1x4	1970	2	—
QD150X400HG	QD150X400SG	QD150X400HW	QD150X400SW	40x100	1½x4	3410	4	3
QD225X400HG	QD225X400SG	QD225X400HW	QD225X400SW	60x100	2¼x4	5300	6	5
QD300X400HG	QD300X400SG	QD300X400HW	QD300X400SW	80x100	3x4	7190	8	7
QD400X400HG	QD400X400SG	QD400X400HW	QD400X400SW	100x100	4x4	9110	11	8
QD600X400HG	QD600X400SG	QD600X400HW	QD600X400SW	150x100	6x4	13,740	16	13

# Q-Duct Approximate dimensions

00.00 Inches  
00.00 [Millimeters]

**.31 - .47" [8-12 mm] slot**  
**.87" [17 mm] height**

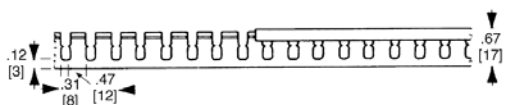

**1.18" [30 mm] height**

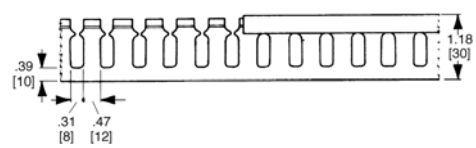

**1.57" [40 mm] height**

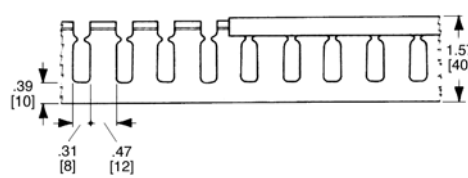

**2.36" [60 mm] height**

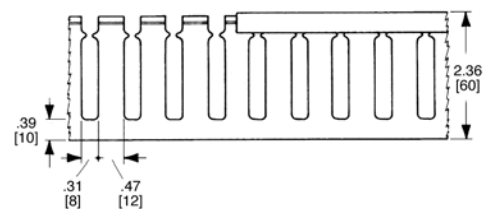

**3.15", 3.94" [80 mm, 100 mm] height**

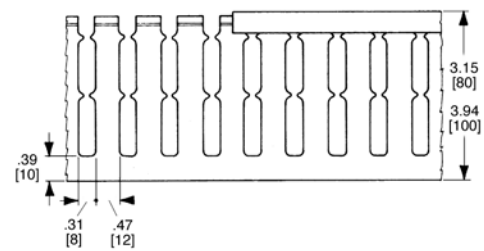

**.16 - .24" [4 - 6 mm] slot**  
**1.47" [40 mm] height**

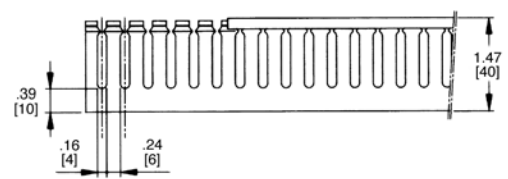

**2.36" [60 mm] height**

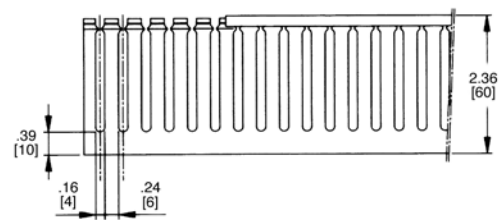

**3.15", 3.94" [80 mm, 100 mm] height**

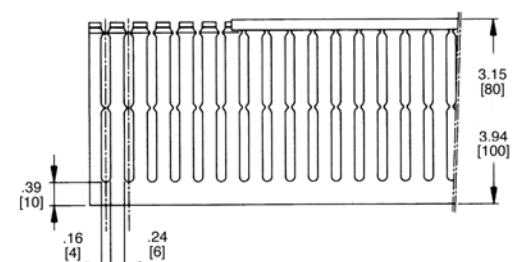

**.16 - .24" [4 - 6 mm] & .31 - .47" [8 - 12 mm] spacing**  
**.59" [15 mm] width**

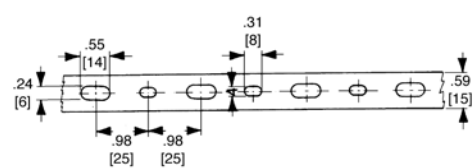

**.98", 1.57", 2.36" [25, 40, 60 mm] width**

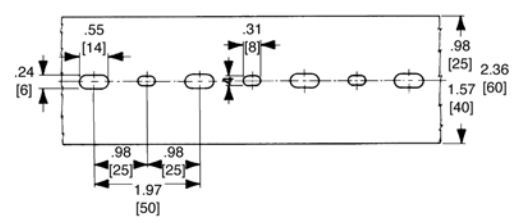

**1.57", 1.97", 2.95" [80, 100, 150 mm] width**

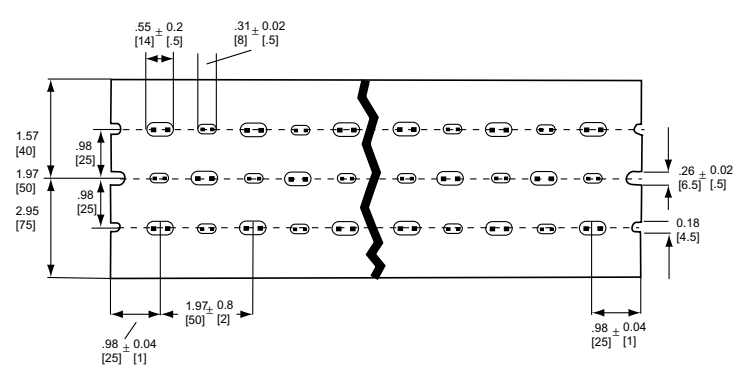

## Q-Duct Part number cross reference

Previous ABB Part Number (Cover included)	New ABB Part Number (Cover included)	Panduct (Cover not included)	Iboco (Cover included)	Thomas & Betts (Cover not included)
<b>Wire duct, gray standard 8-12mm slot</b>				
05019	QD050X050SG	G.5X.5LG6	T1-0506G	T.5X.5TG
05033	QD100X125SG	G1X1LG6	T1-1010G	T1X1TG
05035	QD150X125SG	G1.5X1LG6	-	T1.5X1TG
05037	QD225X125SG	G2X1LG6	-	T2X1TG
05043	QD100X150SG	G1X1.5LG6	T1-1015	T1X1.5TG
05045	QD150X150SG	G2X1.5LG6	T1-1515G	T1.5X1.5TG
05047	QD225X150SG	G2X1.5LG6	T1-2215G	T2X1.5TG
05049	QD300X150SG	-	T1-3015G	-
05051	QD400X150SG	G4X1.5LG6	T1-4015G	-
05053	QD475X150SG	-	-	-
05063	QD100X225SG	G1X2LG6	T1-1022G	T1X2TG
05065	QD150X225SG	G1.5X2LG6	T1-1522G	T1.5X2TG
05067	QD225X225SG	G2X2LG6	T1-2222G	T2X2TG
05069	QD300X225SG	G3X2LG6	T1-3022G	T3X2TG
05071	QD400X225SG	G4X2LG6	T1-4022G	T4X2TG
05073	QD475X225SG	-	-	-
05083	QD100X300SG	G1X3LG6	T1-1030G	T1X3TG
05085	QD150X300SG	G1.5X3LG6	T1-1530G	T1.5X3TG
05087	QD225X300SG	G2X3LG6	T1-2230G	T2X3TG
05089	QD300X300SG	G3X3LG6	T1-3030G	T3X3TG
05091	QD400X300SG	G4X3LG6	T1-4030G	T4X3TG
05093	QD475X300SG	-	-	-
05094	QD100X400SG	G1X4LG6	T1-1040G	T1X3TG
05095	QD150X400SG	G1.5X4LG6	T1-1540G	T1.5X4TG
05096	QD225X400SG	G2X4LG6	T1-2240G	T2X4TG
05097	QD300X400SG	G3X4LG6	T1-3040G	T3X4TG
05098	QD400X400SG	G4X4LG6	T1-4040G	T4X4TG
05099	QD600X400SG	G6X4LG6	T1-6040G	T6X4TG
<b>Wire duct, gray high density 8-12mm slot</b>				
05119	QD050X050HG	-	-	T.5X.5HDG
05133	QD100X125HG	F1X1LG1	-	T1X1HDG
05135	QD150X125HG	F1.5X1LG6	-	T1.5X1HDG
05137	QD225X125HG	F2X1LG6	-	T2X1HDG
05143	QD100X150HG	F1X1.5LG6	T1E-1015G	T1X1.5HDG
05145	QD150X150HG	F1.5X1.5LG6	T1E-1515G	T1.5X1.5HDG
05147	QD225X150HG	F2X1.5LG6	T1E-2215G	T2X1.5HDG
05149	QD300X150HG	-	T1E-3015G	-
05151	QD400X150HG	-	T1E-4015G	-
05153	QD475X150HG	-	-	-
05163	QD100X225HG	F1X2LG6	T1E-1022G	T1X2HDG
05165	QD150X225HG	F1.5X2LG6	T1E-1522G	T1.5X2HDG
05167	QD225X225HG	F2X2LG6	T1E-2222G	T2X2HDG
05169	QD300X225HG	F3X2LG6	T1E-3022G	T3X2HDG
05171	QD400X225HG	F4X2LG6	T1E-4022G	T4X2HDG
05173	QD475X225HG	-	-	-
05183	QD100X300HG	F1X3LG6	T1E-1030G	T1X3HDG
05185	QD150X300HG	F1.5X3LG6	T1E-1530G	T1.5X3HDG
05187	QD225X300HG	F2X3LG6	T1E-2230G	T2X3HDG
05189	QD300X300HG	F3X3LG6	T1E-3030G	T3X3HDG
05191	QD400X300HG	F4X3LG6	T1E-4030G	T4X3HDG
05193	QD475X300HG	-	-	-
05194	QD100X400HG	F1X4LG6	-	T1X4HDG
05195	QD150X400HG	F1.5X4LG6	-	T1.5X4HDG
05196	QD225X400HG	F2X4LG6	-	T2X4HDG
05197	QD300X400HG	F3X4LG6	-	T3X4HDG
05198	QD400X400HG	F4X4LG6	T1E-4040G	T4X4HDG
05199	QD600X400HG	-	-	T6X4HDG

**NOTE:**

1. Sold in package quantity only.
2. All ABB wire duct is sold with covers.
3. Sizes are approximate

# Q-Duct

## Part number cross reference

Previous ABB Part Number	New ABB Part Number	Product (Cover not included)	Iboco (Cover included)	Thomas & Betts (Cover not included)
<b>Wire duct, white standard 8-12mm slot</b>				
1SL5019A00	QD050X050SW	G.5X.5WH6	T1-0506W	T.5X.5TW
1SL5033A00	QD100X100SW	G1X1WH6	T1-1010W	T1X1TW
1SL5035A00	QD150X100SW	G1.5X1WH6	-	T1.5X1TW
1SL5037A00	QD225X100SW	G2X1WH6	-	T2X1TW
1SL5043A00	QD100X150SW	G1X1.5WH6	T1-1015W	T1X1.5TW
1SL5045A00	QD150X150SW	G2X1.5WH6	T1-1515W	T1.5X1.5TW
1SL5047A00	QD225X150SW	G2X1.5WH6	T1-2215W	T2X1.5TW
1SL5049A00	QD300X150SW	-	T1-3015W	-
1SL5051A00	QD400X150SW	G4X1.5WH6	T1-4015W	-
1SL5053A00	QD475X150SW	-	-	-
1SL5063A00	QD100X225SW	G1X2WH6	T1-1022W	T1X2TW
1SL5065A00	QD150X225SW	G1.5X2WH6	T1-1522W	T1.5X2TW
1SL5067A00	QD225X225SW	G2X2WH6	T1-2222W	T2X2TW
1SL5069A00	QD300X225SW	G3X2WH6	T1-3022W	T3X2TW
1SL5071A00	QD400X225SW	G4X2WH6	T1-4022W	T4X2TW
1SL5073A00	QD475X225SW	-	-	-
1SL5083A00	QD100X300SW	G1X3WH6	T1-1030W	T1X3TW
1SL5085A00	QD150X300SW	G1.5X3WH6	T1-1530W	T1.5X3TW
1SL5087A00	QD225X300SW	G2X3WH6	T1-2230W	T2X3TW
1SL5089A00	QD300X300SW	G3X3WH6	T1-3030W	T3X3TW
1SL5091A00	QD400X300SW	G4X3WH6	T1-4030W	T4X3TW
1SL5093A00	QD475X300SW	-	-	-
1SL5094A00	QD100X400SW	G1X4WH6	T1-1040W	T1X3TW
1SL5095A00	QD150X400SW	G1.5X4WH6	T1-1540W	T1.5X4TW
1SL5096A00	QD225X400SW	G2X4WH6	T1-2240W	T2X4TW
1SL5097A00	QD300X400SW	G3X4WH6	T1-3040W	T3X4TW
1SL5098A00	QD400X400SW	G4X4WH6	T1-4040W	T4X4TW
1SL5099A00	QD600X400SW	G6X4WH6	T1-6040W	T6X4TW
<b>Wire duct, white high density 4-6mm slot</b>				
1SL5119A00	QD050X050HW	-	-	T.5X.5HDW
1SL5133A00	QD100X100HW	F1X1WH1	-	T1X1HDW
1SL5135A00	QD150X100HW	F1.5X1WH6	-	T1.5X1HDW
1SL5137A00	QD225X100HW	F2X1WH6	-	T2X1HDW
1SL5143A00	QD100X150HW	F1X1.5WH6	T1E-1015W	T1X1.5HDW
1SL5145A00	QD150X150HW	F1.5X1.5WH6	T1E-1515W	T1.5X1.5HDW
1SL5147A00	QD225X150HW	F2X1.5WH6	T1E-2215W	T2X1.5HDW
1SL5149A00	QD300X150HW	-	T1E-3015W	-
1SL5151A00	QD400X150HW	-	T1E-4015W	-
1SL5153A00	QD475X150HW	-	-	-
1SL5163A00	QD100X200HW	F1X2WH6	T1E-1022W	T1X2HDW
1SL5165A00	QD150X225HW	F1.5X2WH6	T1E-1522W	T1.5X2HDW
1SL5167A00	QD225X225HW	F2X2WH6	T1E-2222W	T2X2HDW
1SL5169A00	QD300X225HW	F3X2WH6	T1E-3022W	T3X2HDW
1SL5171A00	QD400X225HW	F4X2WH6	T1E-4022W	T4X2HDW
1SL5173A00	QD475X225HW	-	-	-
1SL5183A00	QD100X300HW	F1X3WH6	T1E-1030W	T1X3HDW
1SL5185A00	QD150X300HW	F1.5X3WH6	T1E-1530W	T1.5X3HDW
1SL5187A00	QD225X300HW	F2X3WH6	T1E-2230W	T2X3HDW
1SL5189A00	QD300X300HW	F3X3WH6	T1E-3030W	T3X3HDW
1SL5191A00	QD400X300HW	F4X3WH6	T1E-4030W	T4X3HDW
1SL5193A00	QD475X300HW	-	-	-
1SL5194A00	QD100X400HW	F1X4WH6	-	T1X4HDW
1SL5195A00	QD150X400HW	F1.5X4WH6	-	T1.5X4HDW
1SL5196A00	QD225X400HW	F2X4WH6	-	T2X4HDW
1SL5197A00	QD300X400HW	F3X4WH6	-	T3X4HDW
1SL5198A00	QD400X400HW	F4X4WH6	T1E-4040W	T4X4HDW
1SL5199A00	QD600X400HW	-	-	T6X4HDW

**NOTE:**

1. Sold in package quantity only.
2. All ABB wire duct is sold with covers.
3. Sizes are approximate



# Q-Flex Flexible wiring duct

## ABB Q-Flex Flexible wiring duct

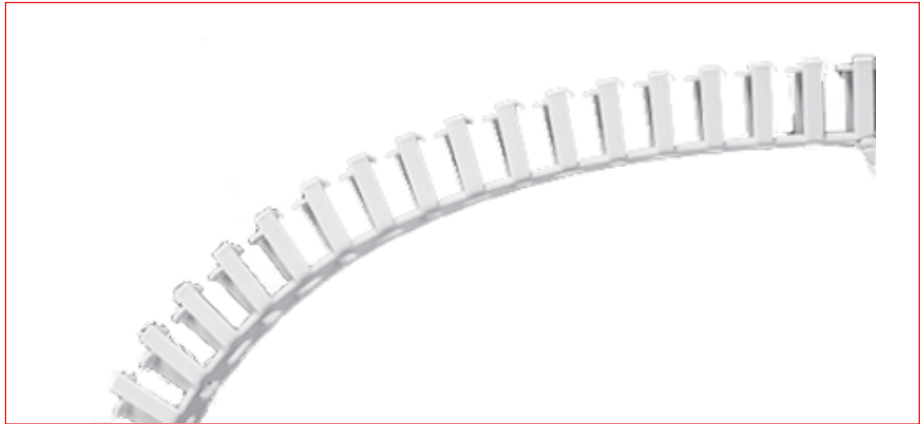

### Flexible wiring duct (500mm )White

Dimensions WXH (in)	Dimensions WXH (mm)	Catalog number	Feet per package	Meters per package	Pieces per package
1/2 x 1/2	12.5 x 12.5	QDF050X050W	184	56	112
5/8 x 5/8	16 x 16	QDF058X058W	138	42	84
3/4 x 3/4	20 x 20	QDF075X075W	184	56	112
1 x 1	25 x 25	QDF100X100W	115	35	70
1 3/4 x 1 3/4	30 x 30	QDF175X175W	82	25	50
1 1/2 x 1 1/2	40 x 40	QDF150X150W	82	25	50
2 x 2	50 x 50	QDF200X200W	52	16	32

### Flexible wiring duct (19.5"), Gray

Dimensions Inside Dia.(in)	Dimensions Inside Dia. (mm)	Catalog number	Feet per package	Meters per package	Pieces per package
0.39	10	QT-10	1148	350	700
0.79	20	QT-20	574	175	350
1.18	30	QT-30	328	100	200
1.58	40	QT-40	164	50	100

Sold in package quantity only. Order quantity must be equal to quantity shown in "pieces per package" column.

### Technical data

- Color RAL 7040 Gray
- Plastic, insulating, shock-proof, self-extinguishing material in compliance with UL 94 V2 Standard and resistant to permanent temperature of 80°C and peaks up to 110°C in compliance with IEC 216 Standards
- Resistant to acids, oils and greases
- Ribs alternate and angle slightly inwards to make it easier to insert and extract cables
- No covers so cables can be constantly monitored
- Possibility of fastening using screws and rivets or bi-adhesive tape which sticks strongly to the steel (pre-mounted)
- Suitable for connecting panels and doors with compass-opening mechanisms and in general for applications where cabling is subject to bending and twisting
- Standard 500mm length



# Q-Wrap spiral wrap

**ABB** Q-Wrap  
Spiral wrap



Height in (mm)	Width in (mm)	Diameter Min / Max in (mm)	Translucent Polyethylene Catalog Number	Self-extinguishing Polyethylene Catalog Number	Length per roll (feet)	Length per roll (meters)
.12 (3)	.2 (5)	.08 (2) / .47 (12)	Q12P164C	Q12SEP164	164	50
.24 (6)	.31 (8)	.2 (5) / 2.20 (56)	Q25P82C	Q24SEP82	82	25
.39 (10)	.43 (11)	.47 (12) / 3.94 (100)	Q39P82C	Q39SEP82	82	25
.47 (12)	.51 (13)	.55 (14) / 5.12 (130)	Q47P82C	Q47SEP82	82	25

## Features and benefits

- Available in two versions:
  - Translucent polyethylene
  - Self-extinguishing polyethylene
- For forming of bundles and grouping of wires
- Mechanical protection of cables
- Flexible connections between panel and door



# Q-Ties tie wraps

**ABB** Q-Ties  
Tie wraps



## Features

- Easy to install and remove
- Provides protection to the wire bundle
- Available in white and black

## Applications

- Fast and economical grouping of wire bundles
- Joining groups of wires and/or tubing
- Flexible connections between door and panel

## Q-Ties Cable ties



Item	Catalog number	Pieces per package	Minimum tensile strength (lbs.)
<b>White (6x6) Polyamide</b>			
3.94" (100mm)x.10" (2.5mm)	QT400-10W	100	24
5.31" (135mm)x.10" (2.5mm)	QT525-10W	100	24
6.30" (160mm)x.10" (2.5mm)	QT625-10W	100	24
5.51" (140mm)x.14" (3.5mm)	QT550-14W	100	44
7.87" (200mm)x.14" (3.5mm)	QT800-14W	100	44
11.02" (280mm)x.14" (3.5mm)	QT1100-14W	100	44
7.09" (180mm)x.17" (4.5mm)	QT700-17W	100	61
11.02" (280mm)x.17" (4.5mm)	QT1100-17W	100	61
14.17" (360mm)x.17" (4.5mm)	QT1400-17W	100	61
7.87" (200mm)x30" (7.5mm)	QT800-30W	100	143
11.02" (280mm)x.30(7.5mm)	QT1100-30W	100	143
14.17" (360mm)x.30(7.5mm)	QT1400-30W	100	143
16.92" (430mm)x.35" (9mm)	QT1700-35W	100	176
21.65" (550mm)x.35" (9mm)	QT2150-35W	100	176
30.71" (780mm)x35" (9mm)	QT3075-35W	100	176
<b>White (6x6 Bulk) Polyamide</b>			
3.94" (100mm)x.10" (2.5mm)	QT400-10WB	1000	24
5.31" (135mm)x.10" (2.5mm)	QT525-10WB	1000	24
6.30" (160mm)x.10" (2.5mm)	QT625-10WB	1000	24
5.51" (140mm)x.14" (3.5mm)	QT550-10WB	1000	44
7.87" (200mm)x.14" (3.5mm)	QT800-14WB	1000	44
<b>Black (6x6) Polyamide</b>			
3.94" (100mm)x.10" (2.5mm)	QT400-10B	100	24
5.31" (135mm)x.10" (2.5mm)	QT525-10B	100	24
6.30" (160mm)x.10" (2.5mm)	QT550-14B	100	24
5.51" (140mm)x.14" (3.5mm)	QT625-10B	100	44
7.87" (200mm)x.14" (3.5mm)	QT800-14B	100	44
11.02" (280mm)x.14" (3.5mm)	QT1100-14B	100	44
7.09" (180mm)x.17" (4.5mm)	QT700-17B	100	61
11.02" (280mm)x.17" (4.5mm)	QT1100-17B	100	61
14.17" (360mm)x.17" (4.5mm)	QT1400-17B	100	61
7.87" (200mm)x30" (7.5mm)	QT800-30B	100	143
11.02" (280mm)x.30(7.5mm)	QT1100-30B	100	143
14.17" (360mm)x.30(7.5mm)	QT1400-30B	100	143
16.92" (430mm)x.35" (9mm)	QT1700-35B	100	176
21.65" (550mm)x.35" (9mm)	QT2150-35B	100	176
30.71" (780mm)x35" (9mm)	QT3075-35B	100	176
<b>Black (6x6 Bulk) Polyamide</b>			
3.94" (100mm)x.10" (2.5mm)	QT400-10BB	1000	24
5.31" (135mm)x.10" (2.5mm)	QT525-10BB	1000	24
6.30" (160mm)x.10" (2.5mm)	QT625-10BB	1000	24
5.51" (140mm)x.14" (3.5mm)	QT550-10BB	1000	44
7.87" (200mm)x.14" (3.5mm)	QT800-14BB	1000	44
<b>Black (12 Polyamide)</b>			
4.53" (115mm)x.24" (6mm)	QT400-24B	100	55
6.89" (175mm)x.24" (6mm)	QT700-24B	100	55
4.53" (115mm)x.24" (6mm)	QT450-35B	100	88
7.09" (180mm)x.35" (9mm)	QT700-35B	100	110
10.43" (265mm)x.35" (9mm)	QT1050-35B	100	110
14.17" (360mm)x.35" (9mm)	QT1400-35B	100	110

Sold in package quantity only.

## Q-Ties Accessories



QTAB-C



QTAB-B



QTCTR



QTSM-B



QTP-INB



QTOCTCTR

### Cable tie accessories

Item	Catalog number	Pieces per package ①
Self-adhesive base for cable ties (clear)	QTAB-C	50
Self-adhesive base for cable ties (black)	QTAB-B	50
Screw mounted base for cable ties (clear)	QTSM-C	100
Screw mounted base for cable ties (black)	QTSM-B	100
Cable tie cutter	QTCTR	1
Screw mounted base for cable ties (clear)	QTSMB	25
Push-in base for cable ties	QTP-INB	25
Outer cable tie cutter	QTOCTCTR	1

① Sold in package quantity only.

# Q-Ties

## Technical data & approximate dimensions

### General features

- Manufactured in 6/6 nylon; Colorless for general uses
- Better stored at mild temperatures, away from heat and excessively dry conditions
- Black cable ties are UV resistant; excellent for outdoor applications

### Thermal properties

- Suitable for use at temperatures from -40° to +110°C
- Softening point VICAT VST/B/50-DIN 53460 over 200°C

### Electrical characteristics





- Dielectric endurance 50,000 V/mm

### Chemical characteristics

- Good resistance to bases, oil, grease, hydrocarbons, acetone, chlorales
- Limited concentrated acid resistance
- Dissolved by phenol and formic acid

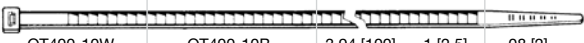
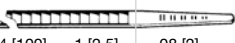
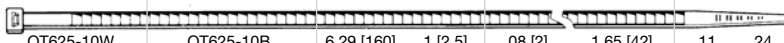
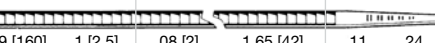
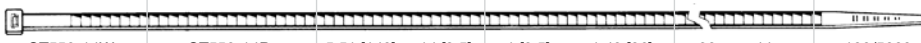
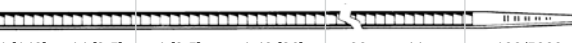
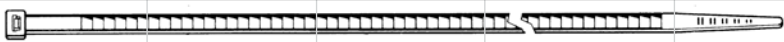
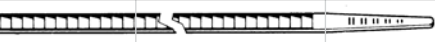
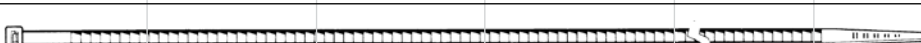
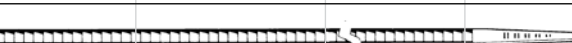
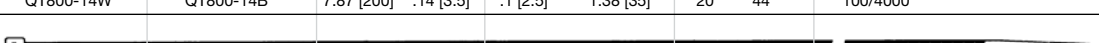
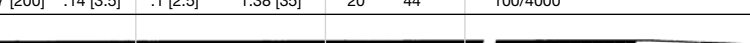
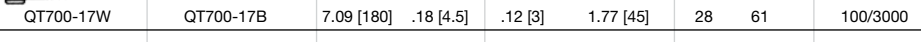
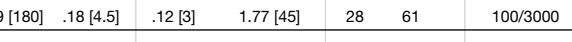
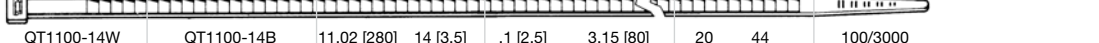
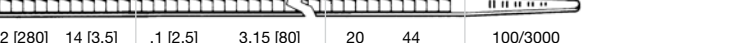
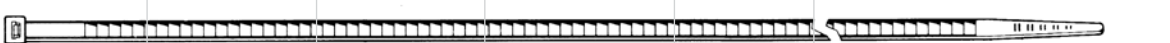
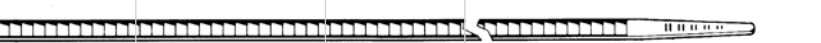
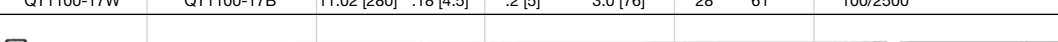
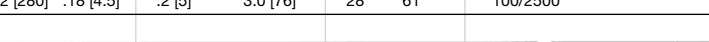
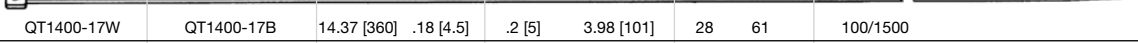
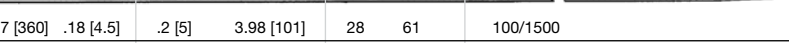
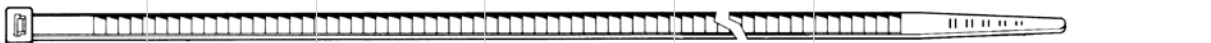
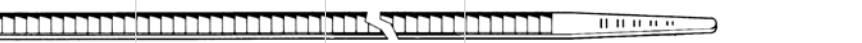
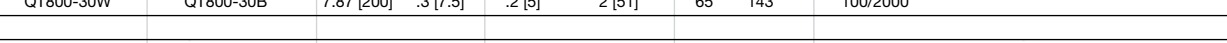
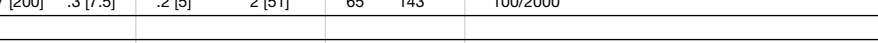
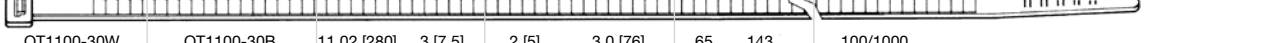
### Mechanical characteristics

- Bending point DIN 53452 110 M Pa
- Load point DIN 53457 2800 M Pa
- Resilience DIN 53453 6-8 KJ/m<sup>2</sup>
- Yield point DIN 53456 80 M Pa
- Stretch point DIN 53455 35%
- Hardness DIN 53456 125 N/mm<sup>2</sup>

White polyamide Catalog number	Black polyamide Catalog number	Size		Tightening diameter		Minimum tightness		Pcs Unit/pack
		L in [mm]	D in [mm]	Minimum in [mm]	Maximum in [mm]	(N)	(lbs.)	
 QT400-10W	 QT400-10B	3.94 [100]	.1 [2.5]	.08 [2]	.94 [24]	11	24	100/8000
 QT625-10W	 QT625-10B	6.29 [160]	.1 [2.5]	.08 [2]	1.65 [42]	11	24	100/5000
 QT550-14W	 QT550-14B	5.51 [140]	.14 [3.5]	.1 [2.5]	1.42 [36]	20	44	100/5000
 QT525-10W	 QT525-10B	5.31 [135]	.1 [2.5]	.08 [2]	1.38 [35]	11	24	100/6000
 QT800-14W	 QT800-14B	7.87 [200]	.14 [3.5]	.1 [2.5]	1.38 [35]	20	44	100/4000
 QT700-17W	 QT700-17B	7.09 [180]	.18 [4.5]	.12 [3]	1.77 [45]	28	61	100/3000
 QT1100-14W	 QT1100-14B	11.02 [280]	.14 [3.5]	.1 [2.5]	3.15 [80]	20	44	100/3000
 QT1100-17W	 QT1100-17B	11.02 [280]	.18 [4.5]	.2 [5]	3.0 [76]	28	61	100/2500
 QT1400-17W	 QT1400-17B	14.37 [360]	.18 [4.5]	.2 [5]	3.98 [101]	28	61	100/1500
 QT800-30W	 QT800-30B	7.87 [200]	.3 [7.5]	.2 [5]	2 [51]	65	143	100/2000
 QT1100-30W	 QT1100-30B	11.02 [280]	.3 [7.5]	.2 [5]	3.0 [76]	65	143	100/1000
 QT1700-35W	 QT1700-35B	16.93 [430]	.35 [9.0]	.2 [5.0]	4.33 [110]	80	176	100/2000
 QT2150-35W	 QT2150-35B	21.65 [550]	.35 [9.0]	.2 [5.0]	5.51 [140]	80	176	100/2000
 QT3075-35W	 QT3075-35B	30.71 [780]	.35 [9.0]	.2 [5.0]	7.48 [190]	80	176	100/800
 QT1400-30W	 QT1400-30B	14.17 [360]	.3 [7.5]	.2 [5.0]	4.02 [102]	65	143	100/2000

# Q-Ties

## Technical data

### Approximate dimensions

#### General features

- Manufactured in 12 nylon
- Moisture absorption less than 1%
- Black cable ties are UV resistant; excellent for outdoor applications

#### Thermal properties

- Suitable for use at temperatures from -30° to +80°C
- Softening point VICAT VST/B/50-DIN 53460 over 160°C

#### Electrical characteristics

- Dielectric endurance 28,000 V/mm

#### Chemical characteristics

- Good resistance to bases, oil, grease, hydrocarbons, acetone, chlorales
- Limited resistance to nitric and chromic acid

#### Mechanical characteristics

- Bending point DIN 53452 20 M Pa
- Load point DIN 53457 420 M Pa
- Breaking load point DIN 53455 61 M Pa
- Resilience 20°C DIN 53453 KJ/m not broken
- Yield point DIN 53456 24 M Pa
- Stretch point DIN 53455 37%
- Hardness G2 Shore D

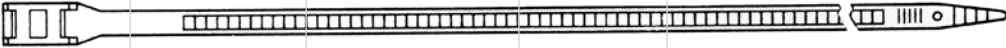
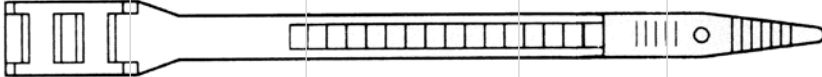
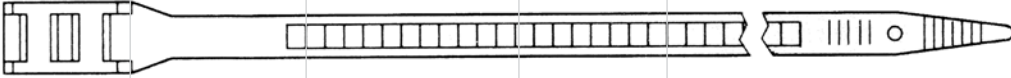
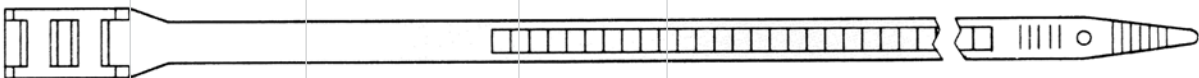
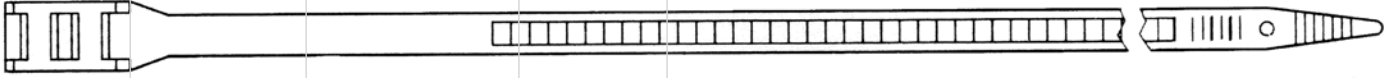
Black polyamide Catalog number	Size		Tightening diameter		Minimum tightness		Pcs Unit/pack
	L in [mm]	D in [mm]	Minimum in [mm]	Maximum in [mm]	(N)	(lbs.)	
 QT400-24B	4.53 [115]	.24 [6]	.2 [5]	.79 [20]	25	55	100/3000
 QT700--24B	6.89 [175]	.24 [6]	.39 [10]	1.57 [40]	25	55	100/2000
 QT450-35B	4.53 [115]	.35 [9]	.2 [5]	.79 [20]	40	88	100/2000
 QT700-35B	7.09 [180]	.35 [9]	.39 [10]	1.77 [45]	50	110	100/2000
 QT1050-35B	10.43 [265]	.35 [9]	.59 [15]	2.75 [70]	50	110	100/1000
 QT1400-35B	14.17 [360]	.35 [9]	.98 [25]	3.94 [100]	50	110	100/800

# Q-Ties Approximate dimensions

00.00 Inches  
00.00 [Millimeters]

**QTAB-C & QTAB-B**  
Self-adhesive base for cable ties

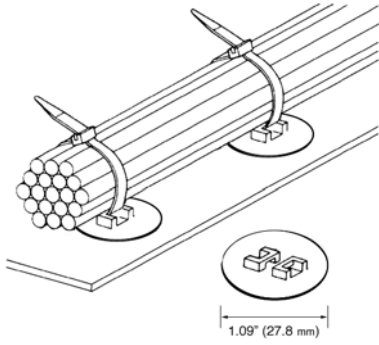

**QTSMB**  
Screw-mounted base for cable ties

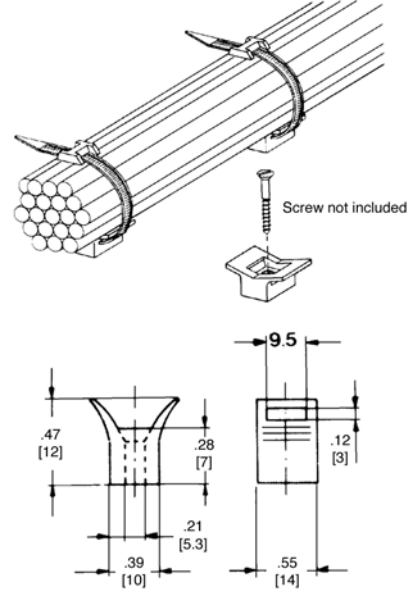

**QTSM-C & QTSM-B**  
Screw-mounted base for cable ties

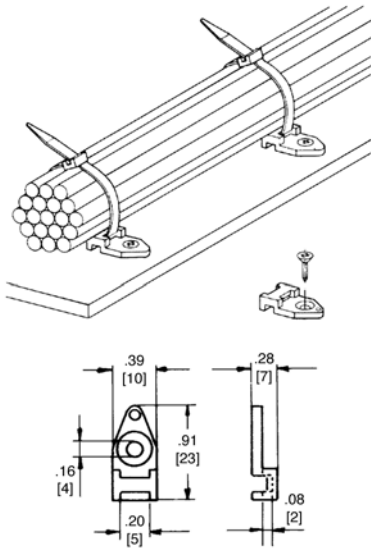

**QTP-INB**  
Push-in base for cable ties

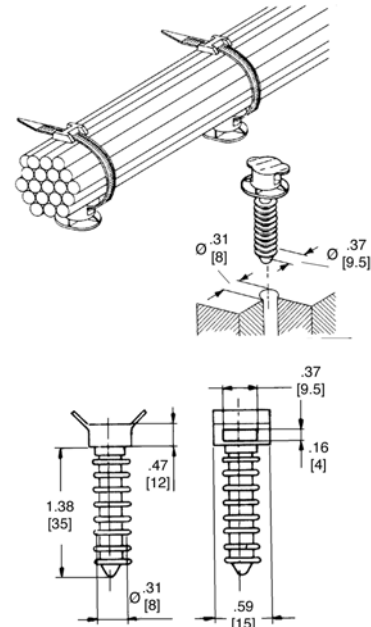

**QTCTR**  
Cable tie cutter

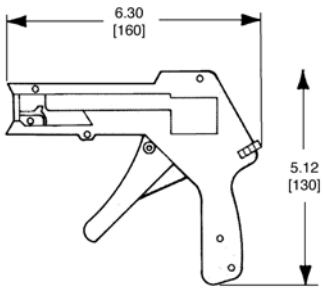

**QTOCTCTR**  
Cable tie cutter

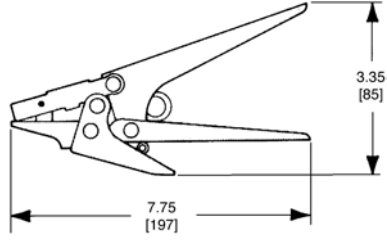





---

**ABB Inc.**  
1206 Hatton Road  
Wichita Falls, TX 76302  
Telephone 888-385-1221; 940-397-7000  
Fax 940-397-7085  
<http://www.abb-control.com>

Publication LV001  
No. 1SXU 811 001 C0202  
Printed in USA, July, 2007